

Reasons you need Ritter Implants

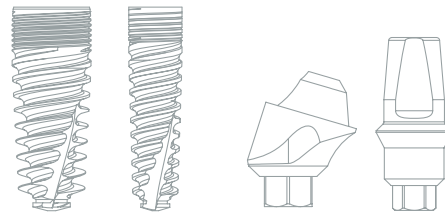

Welcome to Ritter Implants



The name Ritter has been a household name in the dental world for over for more than 135 years. Frank Ritter invented the first dental treatment unit in 1887.

Ritter Implant Production is located near Tuttlingen in southern Germany, on the edge of the Black Forest. The Ritter brand stands for highest quality, state of the art technologies and innovative products – Made in Germany.

Ritter Implants was founded in 2010. Due to the worldwide success of the German implant system, especially in the North American market, Ritter Implants is now expanding in Germany and Europe. The Ritter Implants team, consisting of production, development and marketing specialists, is based in Biberach/Baden-Wuerttemberg.

Our goal is to make implants and implantology accessible to as many people as possible, whereby the well-being of the patient will always be in the foreground for Ritter Implants.



Ritter Academy offers a comprehensive training and course program, as well as exciting events in the dental industry. Get in touch with our implant system.



Check out our
online-shop!



Table of Contents



WHY RITTER IMPLANTS	
04	The Reasons
08	The Implant Surface
09	Titanium Grade 5 ELI
10	Cover and Fixation Screw
11	Implant packaging design
12	The key Implant features
13	Internal HEX-Connection
IMPLANTS	
14	Implant sizes and diameters
16	Platform Switching
18	Emergence Profile
19	Torque values
HEALING CAPS	
20	Healing Caps
IMPRESSION COPINGS	
22	Open and Closed Tray
23	Scan Body
24	Pop Up Impression Procedure
25	Pop Up Impression Parts
PUT SYSTEM	
26	PUT Abutments straight and angled
27	Analogs
28	Single Unit Prosthetic Components
TEMPORARY ABUTMENTS	
29	Peek/Titanium
30	Ti-Base with casting sleeves/for LAB use

TITANIUM ABUTMENTS	
32	Preparable Abutments, straight/angled
35	Across Brand Usability
OVERDENTURE ABUTMENTS	
37	Ball Attachments and Accessories
38	Removable LOCATOR® System by ZEST®
40	Clicq™ Removable Overdenture Abutments
41	Clicq™/Analog and Accessories
42	Clicq™ PLUS Removable Overdenture Abutments
43	Clicq™ PLUS/Analog and Accessories
SCREW RECEIVING MULTI UNIT ABUTMENTS	
46	One Piece Multi-Units straight and angled
47	One Piece Multi-Units straight and angled Kits
48	One Piece Multi-Units Accessories
49	Multi Unit Professional Kit
BIOLOGICS	
51	DentalFix™ Dental Bone Particulate
52	MatrixOI® FlexIT
53	MatrixCollect® 100 DBM Putty
54	MatrixCollect® 100 DBM Crunch
55	ConCelltrate® 100
56	MatrixOI® Cortical Fibers
57	MatrixOI® Fusion Matters
58	Purgo THE Graft™

SUTURES	
59	Monglyc
PRF	
60	DUO Quattro Centrifuge & Accessories
TOOLS	
61	Surgical Instruments & Handpieces
SURGICAL KITS & TOOLS	
63	Compact Surgical Kit
65	Complete Surgical Kit
67	Guided Surgical Kit
68	Prosthetics Kit
69	Components
DRILLING PROTOCOLS	
73	Standard Platform
74	Narrow Line
75	Guided Surgical Kit
76	3D-Libraries
RITTER DENTAL	
78	Dental Units

The Reasons part 1

PAGE 8



Reason #1

Ritter Implants are made of the strongest “**Grade 5**” **Titanium** alloy which goes through a special **sandblasting and etching process**.



PAGE 10



Reason #2

All Ritter Implants include a Cover Screw.



PAGE 10



Reason #3

All Ritter Abutments are packaged including an **Abutment Fixation Screw** made of **Titanium Grade 5**.



PAGE 12



Reason #4

The overall **superior Implant design** attributes to the Ritter Implants Increased primary stability and High Insertion torque values.



PAGE 13



Reason #5

The internal **Hex Connection (Platform)** is the most widely used connection in the industry.

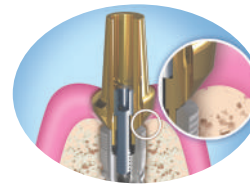

PAGE 15



Reason #6

Ritter Implants has **two platforms** and a wide range of **Platform Shifting/Switching**.

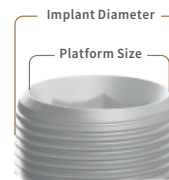

PAGE 15



Reason #7

6 mm **short Implants** in the 5 and 6 mm Diameters.



PAGE 15



Reason #8

Ritter Implants provides a **Narrow Line** with diameters of 3.0/3.3 mm.

Ø 3.0 mm

Ø 3.3 mm



PAGE 18



Reason #9

Ritter Implants Abutments provide an **Emergence Profile** for perfect soft tissue management.



PAGE 22



Reason #10

Ritter Implants is the only company who provides an **Angled Closed Tray Impression Coping, 15°/25°**.



PAGE 23



Reason #11

Ritter Implants **Scan Body/Abutment** is a **dual purpose scan body and temporary/provisional abutment**.



PAGE 24

Reason #12

Ritter Implants Pick Up transfer abutments “PUT” can not only be used for taking an impression but also for the final prosthesis made from Titanium Grade 5. Our “PUT” also come in Angled 15°/25°, exclusively by Ritter Implants.

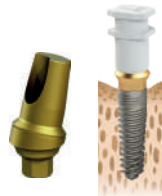

PAGE 28

Reason #13

All Ritter abutment screws are customized to accept the same screw driver - no matter what platform or type of abutment.



PAGE 30

Reason #14

Ritter’s AZA line are made in both Chromium Cobalt and Titanium and are dual purpose as they can be used as Castable with Chromium Cobalt or a Tibase made from Titanium.



PAGE 40

Reason #15

Clicq™ Overdature is known around the world as an “Equator,” offering a narrower profile than traditional overdature abutments.***



PAGE 40

Reason #16

Clicq™ Overdature is manufactured in angled versions encompassing 18° and 30°.***



PAGE 40

Reason #17

Clicq™ Overdature PLUS offers a more traditional wide profile ***



PAGE 42

Reason #18

The Clicq™ overdature Plus is manufactured in angled versions encompassing 18° and 30°.***



PAGE 46

Reason #19

Ritter Multi Abutments have been manufactured with a wider stronger M1.6 screw instead of a M1.4 screw that most companies use on Multi unit restorations. Ritter offers this packaged with very commonly used accessories.

SUPER STRONG!



PAGE 46

Reason #20

Ritter Multi Abutments are also made for its 3.0 and 3.3 Narrow line platform.



*** All Clicq™ products include all the traditional processing parts.

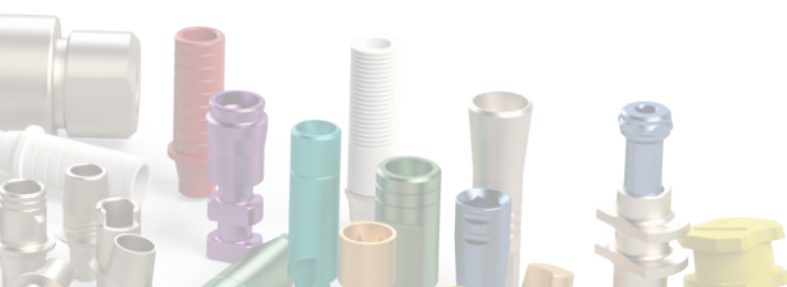

The Reasons part 2

PAGE 49



Reason #21

Multi Unit Kits*: **Special Kit Comes with 36 Abutments** making a complicated procedure much easier!

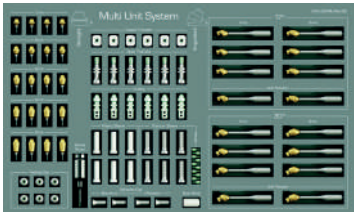

PAGE 44



Reason #22

Ritter Implants were the first to **transition a patient from a removable Denture** to an “all on X” as a removable case can be planned with the “**Angled Clicq™**” abutments.



PAGE 63



Reason #23

All Surgical Kits contain all basic tools to place **all Ritter Platforms**.

PAGE 63



Reason #24

The Compact Surgical Kit contain all basic tools and drill stop function provided by drill **stopper sleeves** with the tools to place **all Ritter Platforms**.



PAGE 63



Reason #25

All Ritter Implants Surgical Kits are equipped with a complete prosthetic selection of the Ratchet, Handpiece, Hand Torque Drivers – **purchase of a separate Prosthetics Kit is unnecessary with Ritter Implants.**

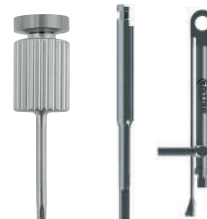

Compact Kit

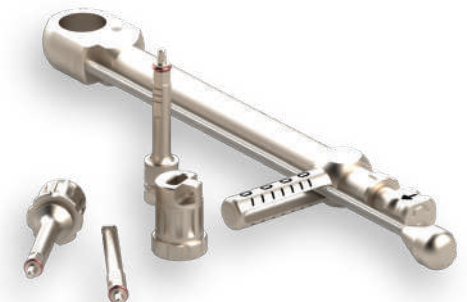

PAGE 65



Reason #26

Our Complete Surgical Kit is the easiest and safest Surgical Kit – containing all the items of the Compact kit- except the **Stoppers** are **built into each drill** – there is a drill for every Implant we produce and more!



PAGE 65



Reason #27

Our Complete Surgical Kit is equipped with our exclusive **3 in 1 Starter/Marking/Lance Drill**.

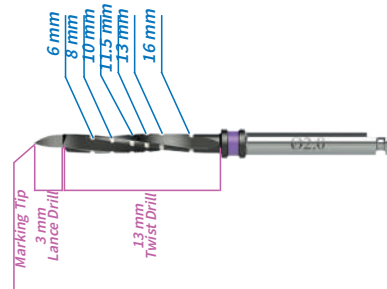

PAGE 65



Reason #28

Our Complete Surgical Kit provides implant placing drivers with **special measuring and registration markings on all tools**.

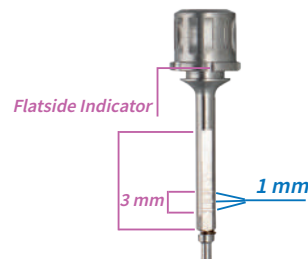

PAGE 65



Reason #29

All Implant Drivers are spring loaded – making it Impossible for an Implant to be dislodged.

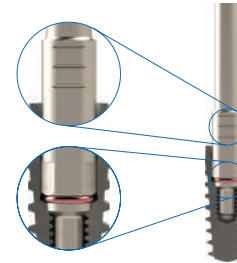

PAGE 67



Reason #30

The **Guided Kit** is one of the Best and Easiest on the Market containing **a drill for every length and diameter**.



PAGE 67



Reason #31

Most guided kits need to use spoons to change drill diameter – **Ritter is spoonless!**

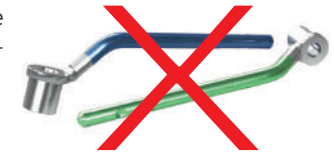

PAGE 67



Reason #32

Most guided kits need metal sleeves in the guide because they guide the cutting portion of the drill – **Ritter guides the barrel of the drill – and is sleeveless!**



PAGE 67



Reason #33

The **Torque Ratchet** has a simple Screw to **reverse the direction of turning**.



Ritter SB/LA method

The Implant surface – Sand blasted with Large Grit, Acid Etched



Reason #1

- 1) There are only two companies who use a certified SB/LA surface treatment. Ritter is one of them.
- 2) Ritter Implants was the first to develop the SB/LA surface on Grade 5 with KKS in Switzerland and it was proven successful.
- 3) Titanium Grade 5 with SLA is still the very best surface treatment in the world.

Ritter Implants are made of a “Grade 5” Titanium alloy (Ti6AL4VELI: 90 % Titanium, 6 % Aluminum, 4 % Vanadium), which goes through a special sandblasting and etching process.

Our method creates large surface differences that allow **strong adsorption of plasma proteins and blood** into the micropores of the implant immediately after insertion.

Benefits

- Bone strengthening due to early Implant contact
- Increased stability
- Shortened healing phase
- Higher predictability of the healing process

Corundum sandblasting and acid etching of the implant surface

- Sandblasting creates a macro surface of 20–40 Mm (microns)
- Double thermal acid etching process creates structures between 1–5 Mm
- Material forms a hydrophilic titanium oxide layer

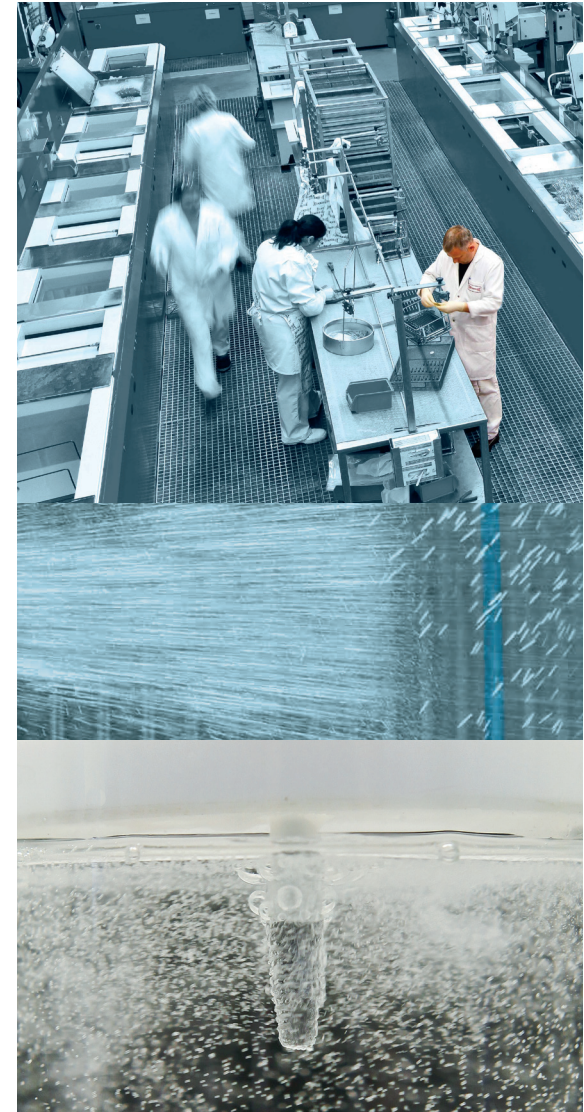

Scan me and watch video about Ritter Implants surface treatment

Titanium Grade 5 ELI

Better physical properties & biocompatibility

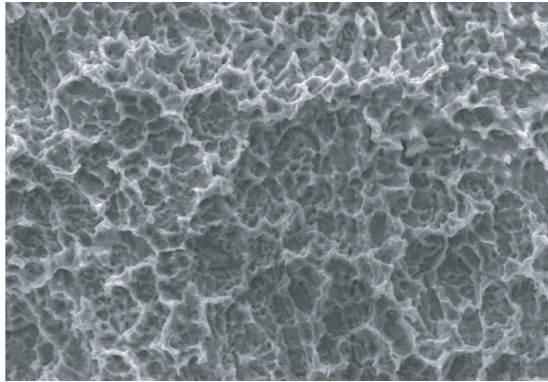

Competitor SEM Image SLA® Surface, Titanium Grade 4

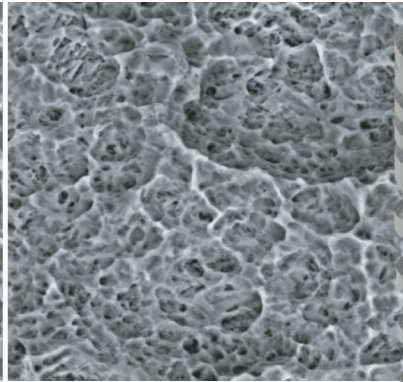

Ritter Implants SB/LA SEM Image, Titanium Grade 5

Both images were taken in **Secondary Electron Mode** but the Ritter Implants image in the backscattering mode of the **electron microscope**.

With the secondary electron mode of Ritter Implants Image the topography is more pronounced while the backscattering mode reflects better the material contrast.

Conclusion: Ritter Implants SB/LA reaches the results even better with alloy Titanium Grade 5, **(Ti6AL4V-ELI: 90 % Titanium, 6 % Aluminum, 4 % Vanadium)**

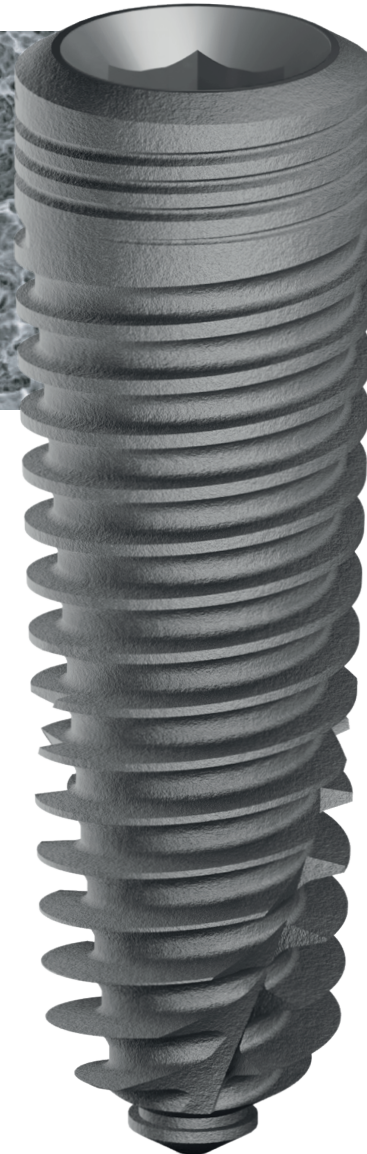

“The excellent biocompatibility and physico-chemical properties of Ti dental implants position Ti as the gold standard in implant dentistry. While the safety and success of Grade 4 Ti is well documented, Grade 5 offers better physical properties and similarly outstanding biocompatibility and survival. As for the various surface modifications, SLA appears to combine the advantages of the physical and chemical methods successfully, making it a favorable alternative. High levels of osseointegration and favourable long-term survival of SLA dental implants were confirmed by several in vitro and clinical studies.” **Based on the current literature, we can conclude that Grade 5 Ti with SLA-modified surfaces assures the best dental implantation outcomes.**

By the ICOI – International Congress of Implantology

Sandblasted, large grit, acid-etched implant surface, (SLA) is a type of surface treatment that creates surface roughness with the goal of enhancing osseointegration through greater bone-to-implant contact (BIC). The SLA process increases the rate at which osseointegration occurs by using a combination of grit and acid etching to give the surface increased roughness on multiple levels. This allows osteoblasts to proliferate and adhere to the implant surface. Through osseointegration, SLA can help provide increased stability of the implant which will ultimately lengthen its longevity. The use of specialized implants by Straumann SLA implants, such as the SLActive implant and the Roxolid SLA implant, reduces the amount of treatment time required while also increasing the treatment predictability. The Roxolid SLA implant can also reduce the need for bone augmentation to assist those patients who have insufficient bone. The SLA process offers a variety of benefits to patients requiring increased ossification prior to an implant.

Cover and Fixation Screw

All Implants & Abutments include screws



Reason #2

Every Ritter Implant
**includes a
Cover Screw**



Reason #3

Every Ritter Abutment
**includes an
Abutment
Fixation Screw**



**Most Ritter Implants Screws
are made of Grade 5 Titanium
and are not comparable to
any other screws!**

Implant packaging design

Clean & safe packed



- Clean & safe packed
- Sophisticated design
- Easy handling



The **LOT Number** is **clearly marked** on the outside, so the treatment team can quickly and reliably identify the diameter and length of the implant.

All implants are supplied in single or 10-packs; while prosthetic components are packed in single 20-packs. (some inventory may still be packed in 6 or 10 packs).

The Ritter Spiral Implant SB/LA is protected by a sealed package with a sterile barrier. The implant is supplied including the Cover Screw, which is located in the bottom lid of the inner tube. (previous packaging)



previous packaging



updated packaging

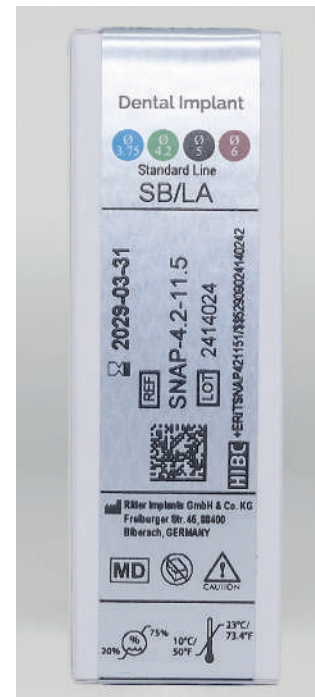

Ritter Implants single package top and side view. The different diameters are color coded and help with easy handling.

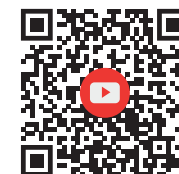

Scan me and watch a video about the packaging usage and handling.

The key features

Ritter Implant Internal HEX construction



Reason #4

The internal hex connection (Platform) is the most widely used connection in the industry – the benefits are that compatible parts exist in every part of the world. **Over 50 % of all Implant production are made with Internal Hex.** This connection (or “platform connection”) is used by Zimmer®, Bio Horizons®, MIS®, Implant Direct Legacy® and many more. The Internal Hex is also the easiest connection to restore against the 2nd most popular connection the **tapered Internal Hex.** Often called a morse taper or conical connection (see next page).

The overall superior Implant design attributes to the Ritter Implants increased primary stability and high insertion torque values.

Connection

Internal Bevel-Hex connection, without micro gaps

Unique Thread

Wider threads in the upper body that increase surface area and reduce bone stress, then transition to sharper threads for self-tapping function

Apical blades

Allow angular adjustment for parallelism during the insertion process

Rounded Apex

The rounded apex minimizes the risk of rupture of the membrane during sinus lift procedures

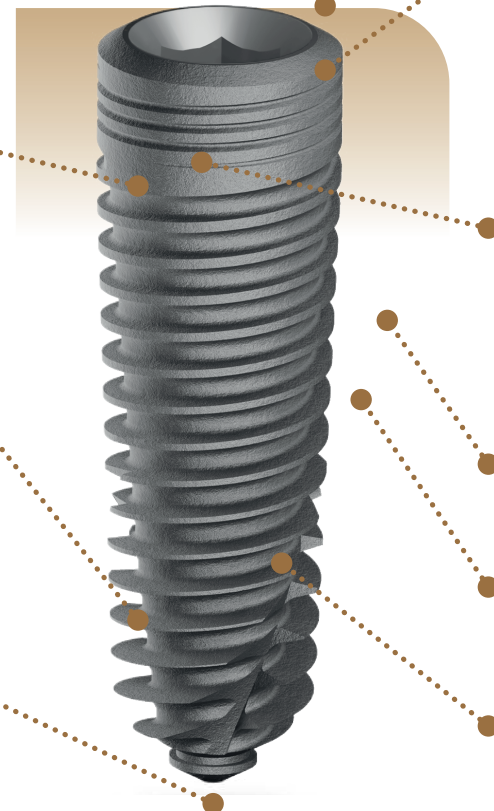
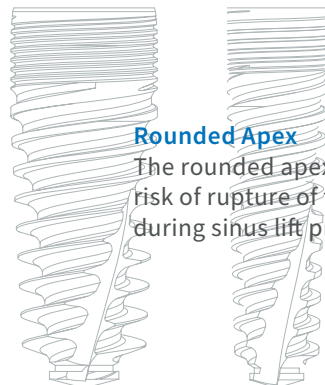

Platform switching

Standard abutments fit all regular diameters 3.75 mm, 4.2 mm, 5 mm & 6 mm

Narrow Line Abutments fit all narrow diameters 3.0 mm & 3.3 mm

Micro Grooves

Add greater surface area and reduce stress on crestal bone, prevent loss of marginal bone and increase “bone-to-implant” contact.

SB/LA

Sandblasted with large particles, acid etched macro surface of 20-40 Mm to a micro surface of about 2 Micrometer, (also called micron, metric unit of measure for length equal to 0.001 mm, or about 0.000039 inch.)

Tapered Body

Increases initial stability while protecting adjacent roots

Dual Cutting Edge

Enhances self-tapping and increases ease of insertion

Progressive Threads

Relaxes stress points in bone, creates better hold in soft bone, suitable for all bone densities

*The brand names® mentioned are protected and the property of their respective brand owners.

Internal HEX-Connection

Platform Switch

Tapered Hex, Morse Taper and Conical Connection are the 2nd most common connection and are used in popular manufacturers such as Nobel®, Hiossen®/Ostem®, Neodent® and Megagen®.

As you can see in the illustration that the body of the abutment engages into the body of the implant. The manufacturers of these products claim that this creates a better seal between the abutment and the Implant than an internal hex. There exist no scientific proof of such myth. **Contrarily the abutment weakens the coronal portion** of the Implant and coronal breakage is very common in these implants. In addition, the tapered shape of the connection creates a cold welding of the abutment into the implant, making nearly impossible to remove or replace an abutment without removing an Implant.

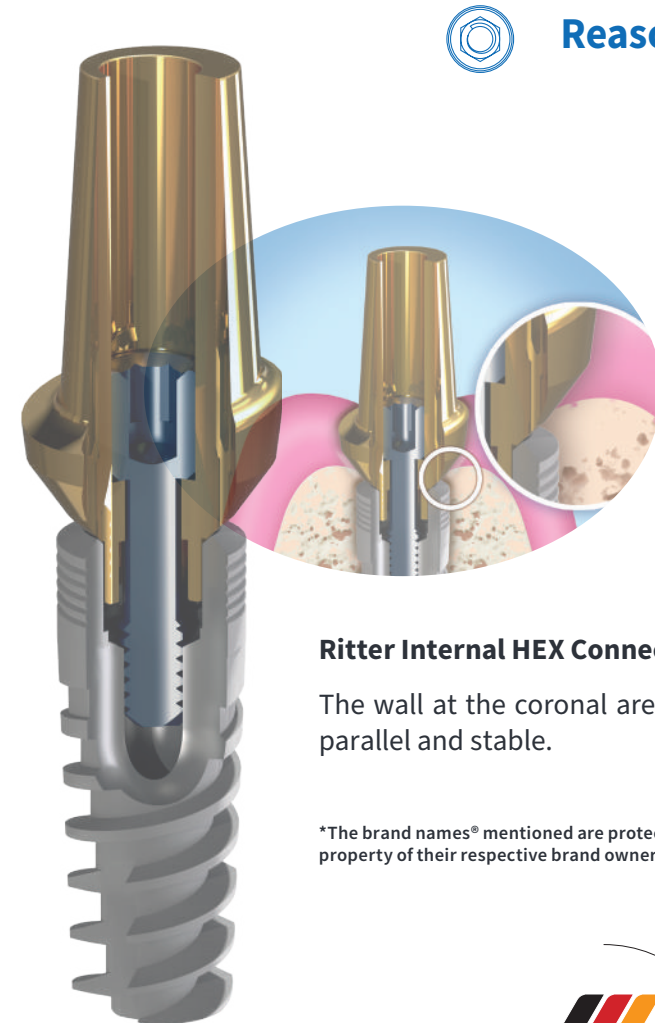
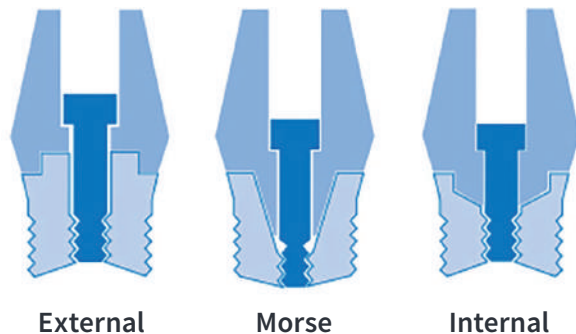

Reason #5

Ritter Internal HEX Connection

The wall at the coronal area is wide, parallel and stable.

*The brand names® mentioned are protected and the property of their respective brand owners.

Ritter Implant sizes and diameters

SNAP SB/LA Implants – all surfaces sand blasted and acid etched

Narrow Line

The different diameters are color coded and help with easy handling.

Standard Platform

The different diameters are color coded and help with easy handling.



Ø Diameter	Ø Platform	Hex-Size	Connection	Length mm	Art.-No.
3.0 mm	2.9 mm	2.0 mm	Internal-Hex 2.9 mm	10	NL-SNAP-3-10
				11.5	NL-SNAP-3-11.5
				13	NL-SNAP-3-13
				16	NL-SNAP-3-16
3.3 mm	2.9 mm	2.0 mm	Internal-Hex 2.9 mm	10	NL-SNAP-3.3-10
				11.5	NL-SNAP-3.3-11.5
				13	NL-SNAP-3.3-13
				16	NL-SNAP-3.3-16
3.75 mm	3.75 mm	2.43 mm	Internal-Hex 3.75 mm	8	SNAP-3.75-8
				10	SNAP-3.75-10
				11.5	SNAP-3.75-11.5
				13	SNAP-3.75-13
				16	SNAP-3.75-16
4.2 mm	3.75 mm	2.43 mm	Internal-Hex 3.75 mm	8	SNAP-4.2-8
				10	SNAP-4.2-10
				11.5	SNAP-4.2-11.5
				13	SNAP-4.2-13
				16	SNAP-4.2-16
5.0 mm	3.75 mm	2.43 mm	Internal-Hex 3.75 mm	6	SNAP-5-6
				8	SNAP-5-8
				10	SNAP-5-10
				11.5	SNAP-5-11.5
				13	SNAP-5-13
				16	SNAP-5-16
6.0 mm	3.75 mm	2.43 mm	Internal-Hex 3.75 mm	6	SNAP-6-6
				8	SNAP-6-8
				10	SNAP-6-10
				11.5	SNAP-6-11.5
				13	SNAP-6-13



Reason #6

This wide range of Platform Shifting/Switching.

Ritter Implants has **two Platforms**. Our Standard Platform encompasses the most popular Diameters of Implants and thus Ritter has the capability of Platform Shifting from 3.75 mm all the way to 6 mm in diameter, in total a complete line with **21 different sizes using the same Platform Diameter/Platform Connection/Abutments/Healing Caps – over 1000 different prosthetics fit into this group of Implants.**



Reason #7

The Standard Platform is also known as the Standard Line features with **6 mm short Implants in the 5 mm and 6 mm Diameters.**



Reason #8

The Narrow Platform 2.9 mm encompassing **8 additional Implants in 3.0 mm and 3.3 mm Implants** – for obvious reasons they cannot be on the same diameter platform as the Standard Line. Our Platform have a full line of Multi Unit and Overdenture Abutments – rendering the need for ONE PIECE or MINI Implants to be obsolete because you can restore all options with this Narrow Implant and are not tied to cement or permanently fused abutments. The parts for this platform are **always depicted in purple fonts and colors.**

ONE PIECE or commonly called Mini Implants tie the patient to the same type of prosthesis, he/she must have the old Implants removed in order to upgrade their prosthesis.

Platform Shift/Platform Switch

SNAP SB/LA Implants – each size Standard Platform

Important information here about the sizes of the Implants. In addition to different types of Platform Connections **most companies have several platform diameters.** Ritter has only two!

The “**platform (diameter)**” is described as the diameter of the point where the abutment seals to the implant. The **platform** is represented by the platform size. In the past Implant companies

made a platform for each Diameter Implant or paired most similar two diameter Implants into one platform diameter. This is known as **Platform Matching.**

Standard Platform

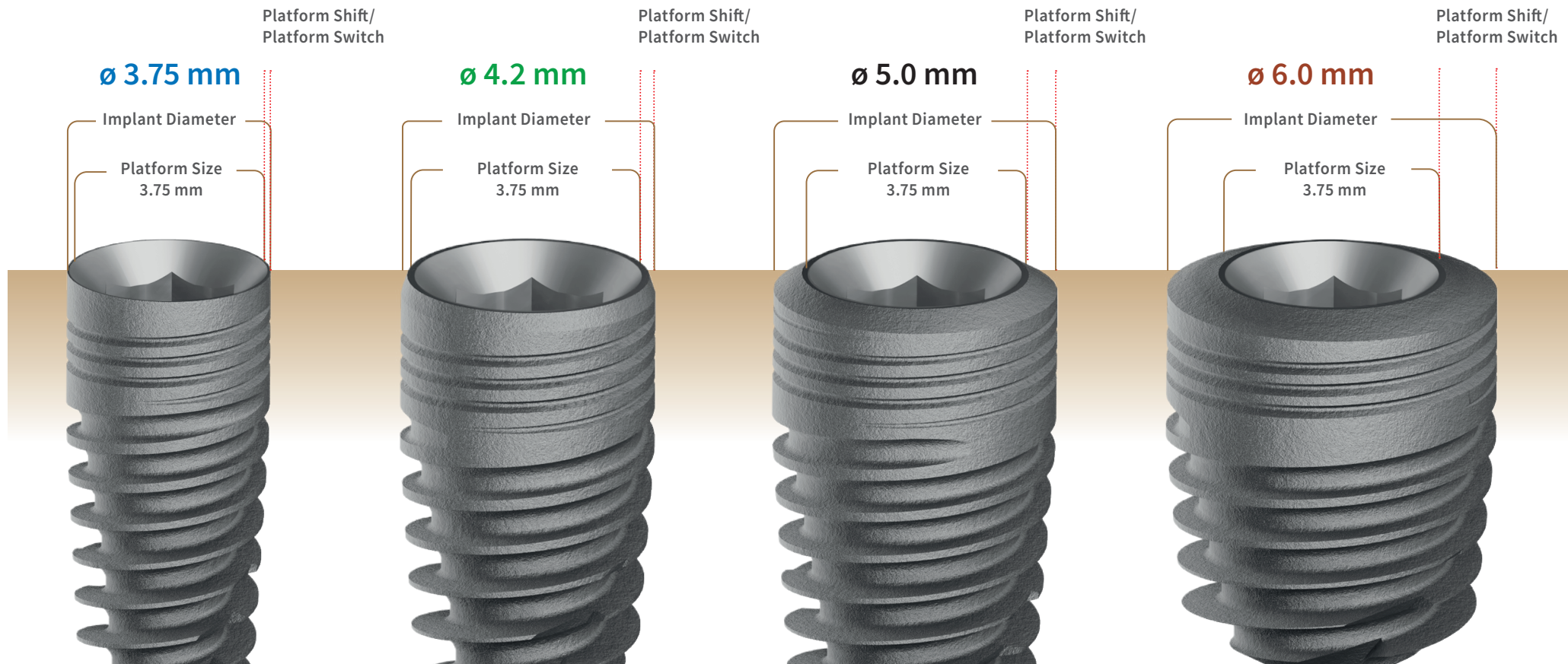

Data later showed that if the abutment connection diameter (platform) was less wide than the Implants actual Diameter – then more bone would grow over the neck of the implant. This phenomenon became know as **Platform shifting** or **Platform Switching**.

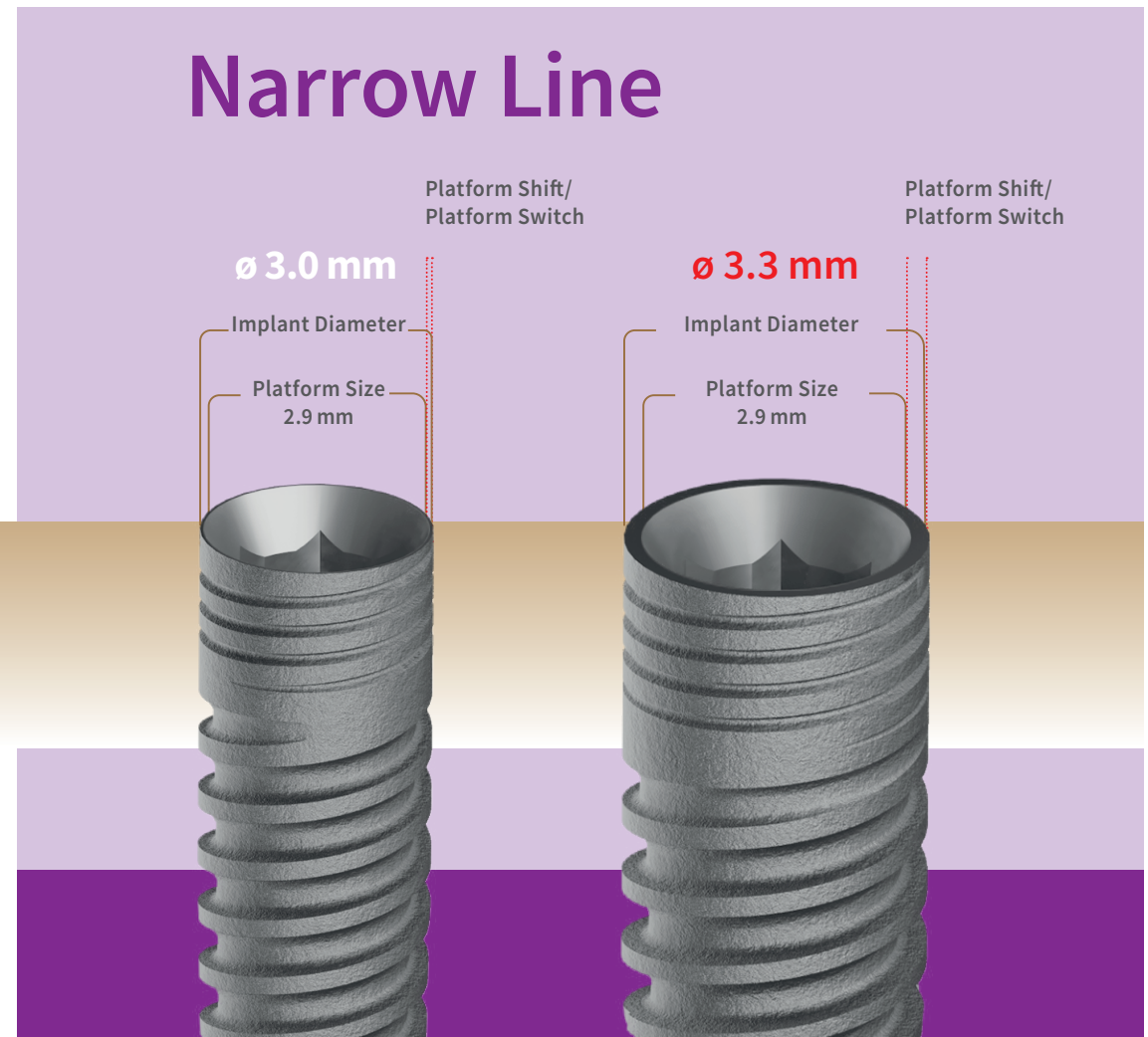

Emergence Profile

Ritter Vertical Platform Shift



Reason #9

Vertical Platform Switch Profile – Ritter was the first to produce a full line of these products to promote soft tissue healing and growth but also so that an Implant may be placed sub-crestal (below the bone).

The shape of the shoulder or the flare out of the abutment as it comes out of the implant is called the **Emergence Profile**.

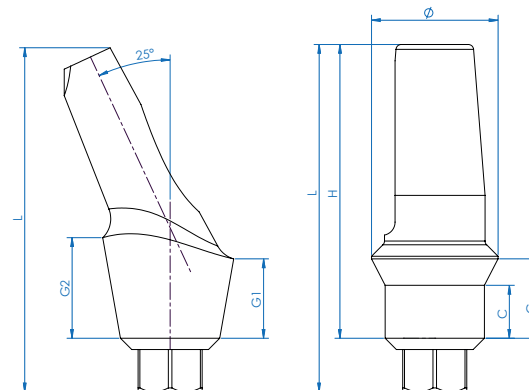
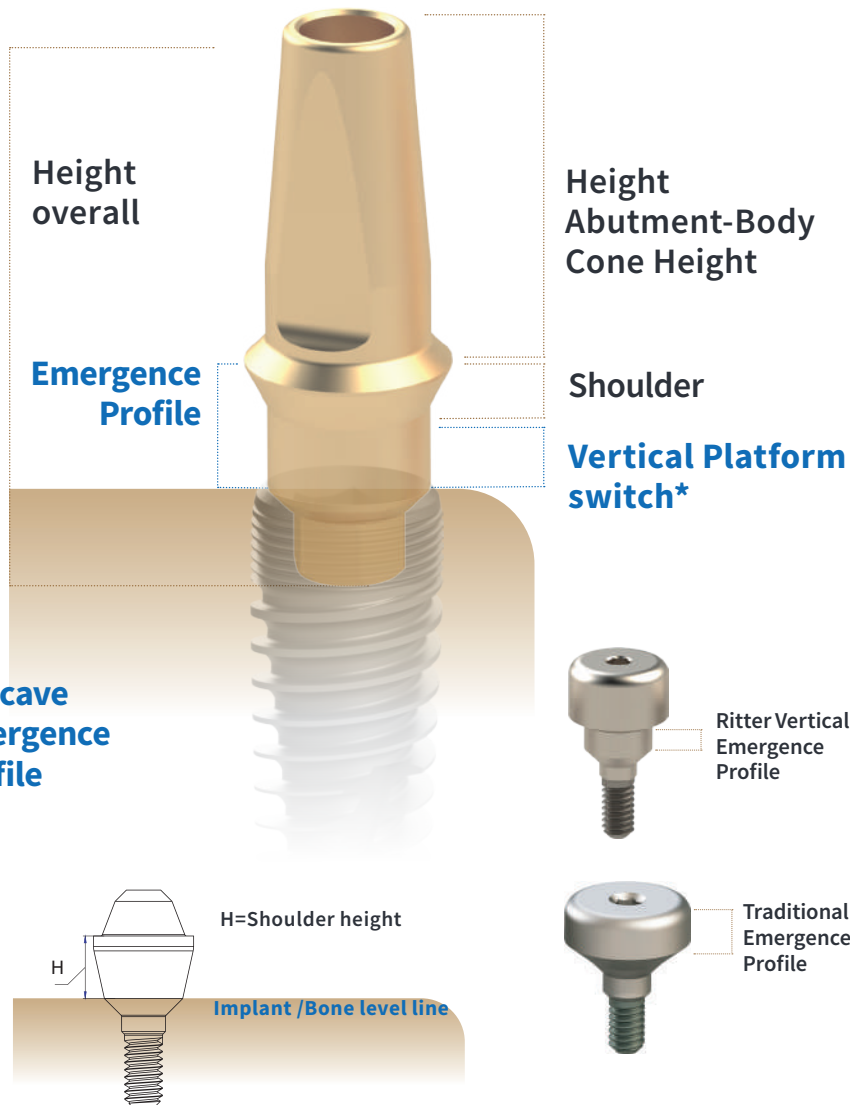

Symbol	Meaning
L	Total length
H	Length from platform to top edge
G	Gingival height
G1	Gingival height on short side
G2	Gingival height on long side
Ø	Diameter at widest point
C	Collar height of platform switch
NL	Narrow Line for 3.0 & 3.3 mm Ø Implants

Shoulder, Collar, Gingival Margin, Gingival height – all mean the same thing – as the abutment emerges off the platform of the Implant to shape the soft tissue (gums/gingiva/sulcus) and rises to a certain height which matches the height distance of a persons bone level to the depth of the tissue.

* All Platform switching products are equipped with a 1.5 mm vertical platform switching unless otherwise specified. Soft tissue management support in preparation for vertical platform switching.

Torque values

Torque values recommended by Ritter for Implants and Abutments



Implant Insertion Torque: Its Role in Achieving Primary Stability of Restorable Dental Implants.

Gary Greenstein, John Cavallaro

A literature review was conducted to determine the role of insertion torque in attaining primary stability of dental implants. The review is comprised of articles that discussed the amount of torque needed to achieve primary implant stability in healed ridges and fresh extraction sockets prior to immediate implant loading. Studies were appraised that addressed the effects of minimum and maximum forces that can be used to successfully place implants. The minimum torque that can be employed to attain primary stability is undefined. Forces ≥ 30 Ncm are routinely used to place implants into healed ridges and fresh extraction sockets prior to immediate loading of implants. Increased insertion torque (≥ 50 Ncm) reduces micromotion and does not appear to damage bone. In general, the healing process after implant insertion provides a degree of biologic stability that is similar whether implants are placed with high or low initial insertion torque. Primary stability is desirable when placing implants, but the absence of micromotion is what facilitates predictable implant osseointegration. Increased insertion torque helps achieve primary stability by reducing implant micromotion.

Furthermore, tactile information provided by the first surgical twist drill can aid in selecting the initial insertion torque to achieve predictable stability of inserted dental implants.



Please scan for review

Implant Insertion Torque: Its Role in Achieving Primary Stability of Restorable Dental Implants

Gary Greenstein, John Cavallaro

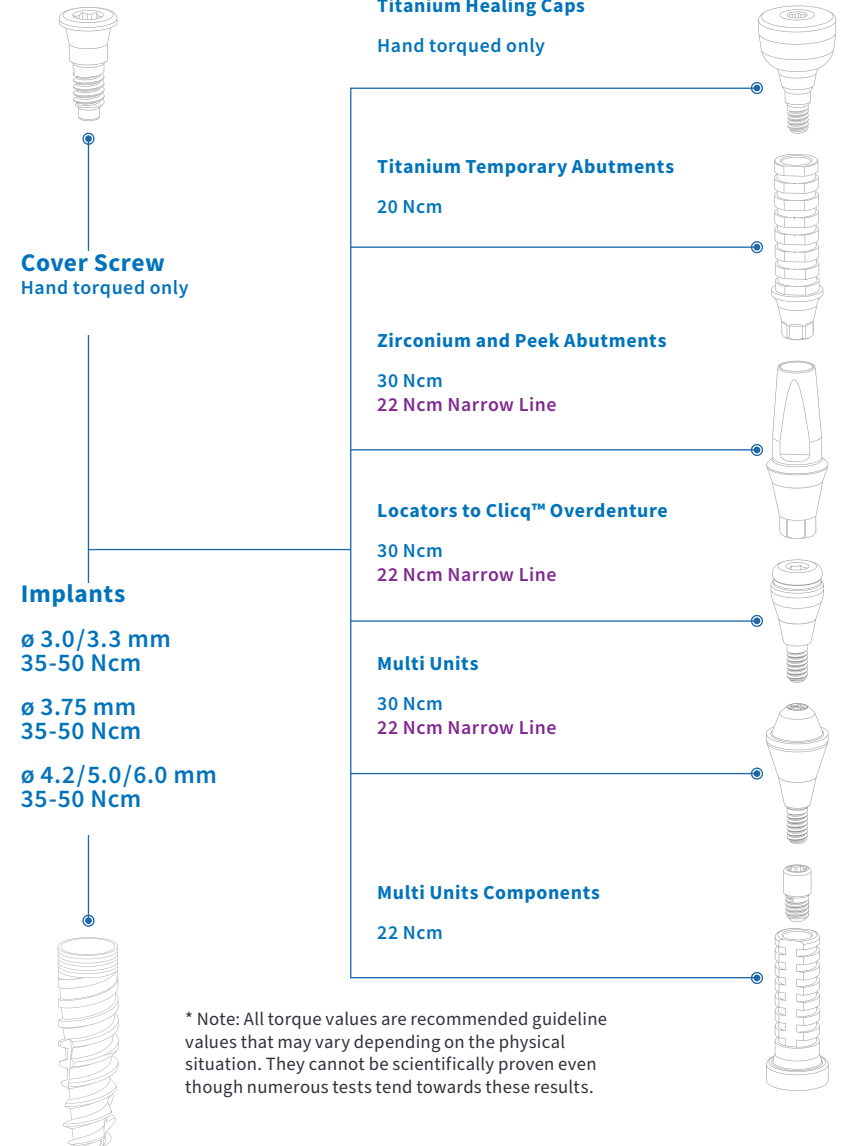
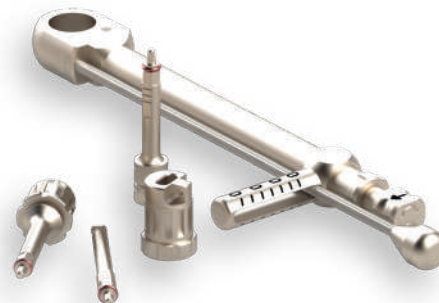

* Note: All torque values are recommended guideline values that may vary depending on the physical situation. They cannot be scientifically proven even though numerous tests tend towards these results.

Healing Caps/Gingiva Formers

Preparing the soft tissue for the final Prosthesis

Standard Platform



Healing Caps/Healing Abutments/Gingiva Formers/ Sulcus Formers – this item is used to shape the gums after the implants has been placed and healed. The diameters, heights and shapes are to be decided by the dentist as to prepare and shape the gums for the final Crown/Prosthesis.

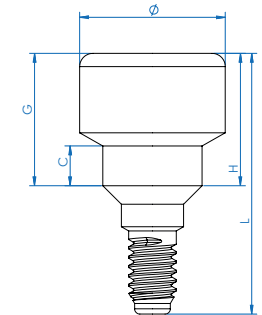

Symbol	Meaning
L	Total length
H	Length from platform to top edge
G	Gingival height
Ø	Diameter at widest point
C	Collar height of platform switch
NL	Narrow Line for 3.0 & 3.3 mm Ø Implants

Healing Caps – Narrow Line

The narrow diameters/Narrow Line \varnothing 3.0 and \varnothing 3.3 mm



NL-HC-3 Narrow Line
H 3 mm | \varnothing 4.5 mm

NL-HC-3C Narrow Line
H 3 mm | \varnothing 4.5 mm
C= 1.5 mm Collar
Vertical Platform switching

NL-HC-3N Narrow Line slim
H 3 mm | \varnothing 3.8 mm



NL-HC-5 Narrow Line
H 5 mm | \varnothing 4.5 mm

NL-HC-5C Narrow Line
H 5 mm | \varnothing 4.5 mm
C= 1.5 mm Collar
Vertical Platform switching

NL-HC-5N Narrow Line slim
H 5 mm | \varnothing 3.8 mm

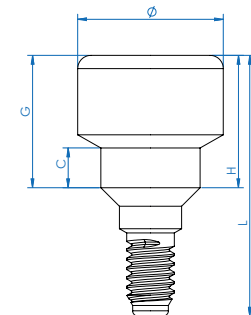

Symbol	Meaning
L	Total length
H	Length from platform to top edge
G	Gingival height
\varnothing	Diameter at widest point
C	Collar height of platform switch
NL	Narrow Line for 3.0 & 3.3 mm \varnothing Implants

Impression Copings

Open and Closed Tray procedure

Closed Tray transfer



ACT-15 Standard Line - 15° angled
Closed Tray Transfer
H 11 mm | Ø 4.4 mm,
Incl. TSA-8.3 screw

ACT-25 Standard Line - 25° angled
Closed Tray Transfer
H 10.9 mm | Ø 4.4 mm
Incl. TSA-8.3 screw



NL-ACT-15 Narrow Line - 15° angled
Closed Tray Transfer
H 11 mm | Ø 4.8 mm
Incl. NL-TSA-8.3 screw

NL-ACT-25 Narrow Line - 25° angled
Closed Tray Transfer
H 11 mm | Ø 4.8 mm
Incl. NL-TSA-8.3 screw

NL = Narrow Line for 3.0 & 3.3 mm Ø Implants



Reason #10

Angled Closed Tray – This allows a doctor to take an Impression of two angled implants at the same time that would otherwise not be possible and require two Impressions to be taken – this makes Ritter unique!



Impression Copings, Impression Pins, Impression Abutments or Impression Posts – they all mean the same.

These are used to register the depth and orientation of the Implant inside the bone as it relates to the surrounding teeth so that the laboratory can fabricate the crown/ Final Prosthesis.

Closed Tray - this part is screwed into the implant and a traditional Impression is taken over this part. When the material is dried in the mouth – the impression tray is removed. An impression of the part is left inside the material. The tray is sent to the laboratory who in turn reverse pours a model into a replica of the teeth and now can build the final prosthesis to screw into the implant. The closed tray Impression coping is then unscrewed and kept by the doctor for possible future use after sterilization.

Open Tray – same process except that the coping tray stays inside the tray and goes to the lab - this make the labs job easier and is more accurate – because the lab can attach the analog to the open tray providing the exact position and creating the mouth replica at the same time/step.

Impression Copings

Open and Closed Tray procedure/Scan Body/Scan Abutment



Closed Tray transfer



CTT-10.8N

Standard Line slim
Closed Tray Transfer
H 10.9 mm | Ø 3.8 mm
Incl. TSCT-14 screw

NL-CTT-10.8N

Narrow Line slim
Closed Tray Transfer
H 10.9 mm | Ø 3.8 mm
Incl. NL-TSCT-14 screw



CTT-13.8N

Standard Line slim
Closed Tray Transfer
H 13.9 mm | Ø 3.8 mm
Incl. TSCT-17 screw

NL-CTT-13.8N

Narrow Line slim
Closed Tray Transfer
H 13.9 mm | Ø 3.8 mm
Incl. NL-TSCT-17 screw



Top view

Open Tray transfer



OTT-10.8N

Standard Line slim
Open Tray Transfer
H 10.8 mm | Ø 4 mm
Incl. TSOT-24 screw

NL-OTT-10.8N

Narrow Line slim
Open Tray Transfer
H 10.8 mm | Ø 3.8 mm
Incl. NL-TSOT-24 screw



OTT-13.8N

Standard Line slim
Open Tray Transfer
H 13.9 mm | Ø 4 mm
Incl. TSOT-24 screw

NL-OTT-13.8N

Narrow Line slim
Open Tray Transfer
H 13.9 mm | Ø 3.8 mm
Incl. NL-TSOT-24 screw

OTT-13.8W

Standard Line wide
Open Tray Transfer
H 13.9 mm | Ø 5.5 mm
Platform switching
Incl. TSOT-24 screw

Scan Body/Abutment – these are used to avoid Open and Closed Tray traditional ANALOG impressions. They register a digital Impression of the location of the Implant. This product is preformed and made from Peek. Peek is the most common plastic material to make temporary crowns; therefore this a **dual purpose scan body and temporary/provisional abutment.**

Temporary Abutments are commonly made after the Impression is made. An impression is taken to make a final crown/prosthesis which can take a few weeks and that is why a Temporary or also know as provisional is needed.



Reason #11



3DSPA-8C

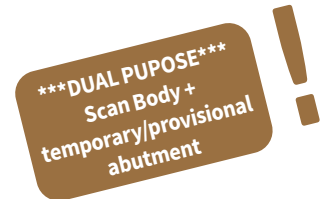

Scan Abutment
Standard Line
Plastic Abutment for 3D Scanner
5 mm Abutment-body,
1.6 mm Shoulder
C= 1.5 mm Vertical Platform switching
Incl. TSA-8.3 screw

NL-3DSPA-8C

Scan Abutment
Narrow Line
Plastic Abutment for 3D Scanner
5 mm Abutment-body,
1.6 mm Shoulder
C= 1.5 mm Vertical Platform switching
Incl. NL-TSA-8.3 Screw

Pop Up Impression with PUT

All in one Pop Impression Transfer Abutment

*****MULTI PURPOSE***
All PUT-XX can be used as
Impression, Healing, Temporary
and Final Abutment!**



Reason #12

The following pick transfer abutments are another way to take an impression with Ritter. Our abutments are made with Grade 5 titanium and can not only be used for taking an impression but also for the final prosthesis. Our Pick up Transfer abutments also come in Angled (no one else has this). This is the ability to use for a final/angled and Vertical shift pick transfer abutments from Ritter.

1.

Place PUT Abutment with flat side facing the buccal side and hand tighten with HHDA 1.25 hex tool.

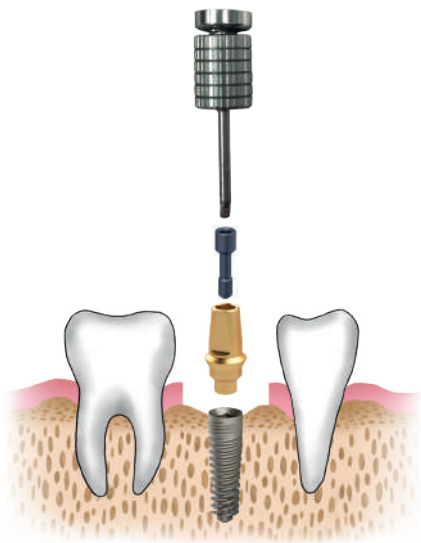

2.

Torque to 30 Ncm.



One week

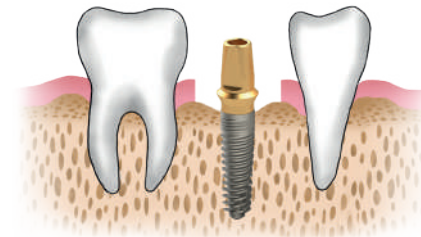

3.

Place PUP-CA Impression Cap on PUT Abutment, aligning flat interior of PUP-CA with the flat of the PUT Abutment (which should be facing the buccal). Press downward until you feel the parts snap into place.

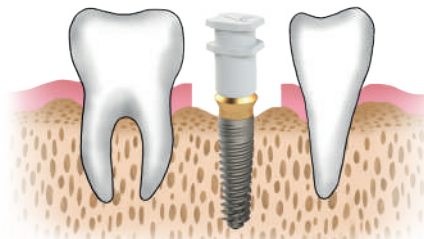

4.

Place impression tray over components until hardened and remove tray.



5.

The PUP-CA will remain in the tray.



6. Send tray along with the appropriate IA-PUT (S, M, L) to lab for your final crown.



7. Place the TC-PUT on PUT Abutment until final restoration is delivered. (Alternatively, a temporary crown may be placed directly on the PUT Abutment.)

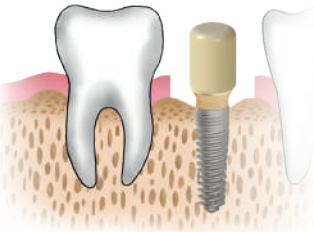

8. Original PUT Abutment is ready for final restoration.

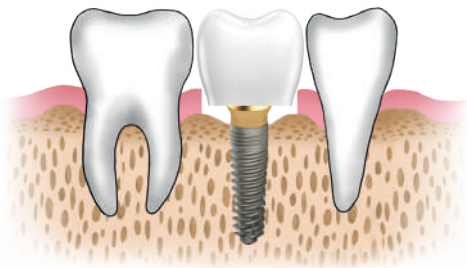

PUT accessories: **PUP CA:** closed tray Impression – included with PUT abutment **WS:** Waxing Sleeves are used by the laboratory to clone the shape of the abutment inside the crown.

TC: The dentist may leave the PUT abutment in the mouth and use the TC as a healing cap or temporary crown.



PUP-CA Plastic cap for PUT-S, M & L



WS-PUT Wax Sleeve for all PUT Abutments (red) not rotational



WS-PUT-R Wax Sleeve for all PUT Abutments (white) rotational

TC-PUT-S Temporary Cap (4 mm) for PUT-S



TC-PUT-M Temporary Cap (6 mm) for PUT-M

TC-PUT-L Temporary Cap (8 mm) for PUT-L

IA: is the Analog which replicates the abutment **THEREFORE IT IS AN ABUTMENT LEVEL ANALOG PARTICULARLY FOR THE PUT LINE ONLY** – this is only used if the dentist places the PUT abutment in the mouth and leaves it in until the crown returns – in this case he inserts the abutment analog into the pup ca after the impression is hardened – then ships to the laboratory.



IA-PUT-S Analog for PUT-S (4 mm) Abutment

IA-PUT-M Analog for PUT-M (6 mm) Abutment

IA-PUT-L Analog for PUT-L (8 mm) Abutment

PUT System

The diameters, heights and shapes are to be decided by the dentist as to prepare and shape the gums for the final crown/prosthesis.

Platform switching PUT System



*****MULTI PURPOSE*****
All PUT-XX can be used as
Impression, Healing, Temporary
and Final Abutment!



Standard platform

PUT-1S	4 mm Abutment-Body, 1.1 mm Shoulder
PUT-1SC	4 mm Abutment-Body, 0.6 mm Shoulder C= 0,5 mm Vertical Platform switching
PUT-1M	6 mm Abutment-Body, 1.1 mm Shoulder
PUT-1MC	6 mm Abutment-Body, 0.6 mm Shoulder C= 0.5 mm Vertical Platform switching
PUT-1L	8 mm Abutment-Body, 1.1 mm Shoulder
PUT-1LC	8 mm Abutment-Body, 0.6 mm Shoulder C= 0.5 mm Vertical Platform switching
PUT-2S	4 mm Abutment-Body, 2.1 mm Shoulder
PUT-2SC	4 mm Abutment-Body, 1.1 mm Shoulder C= 1 mm Vertical Platform switching
PUT-2M	6 mm Abutment-Body, 2.1 mm Shoulder
PUT-2MC	6 mm Abutment-Body, 1.1 mm Shoulder C= 1 mm Vertical Platform switching
PUT-2L	8 mm Abutment-Body, 2.1 mm Shoulder
PUT-2LC	8 mm Abutment-Body, 1.1 mm Shoulder C= 1 mm Vertical Platform switching
PUT-3S	4 mm Abutment-Body, 3.1 mm Shoulder
PUT-3SC	4 mm Abutment-Body, 1.1 mm Shoulder C= 2 mm Vertical Platform switching



PUT-3MC	6 mm Abutment-Body, 1.1 mm Shoulder C= 2 mm Vertical Platform switching
PUT-3L	8 mm Abutment-Body, 3.1 mm Shoulder
PUT-3LC	8 mm Abutment-Body, 1.1 mm Shoulder C= 2 mm Vertical Platform switching
PUT-4L	8 mm Abutment-Body, 4.1 mm Shoulder



PUT-15-1M	15° angles 6 mm Abutment-Body, 1 mm Shoulder
PUT-15-2M	15° angles 6 mm Abutment-Body, 2 mm Shoulder
PUT-15-3M	15° angles 6 mm Abutment-Body, 3 mm Shoulder
PUT-25-1M	25° angles 6 mm Abutment-Body, 1 mm Shoulder
PUT-25-2M	25° angles 6 mm Abutment-Body, 2 mm Shoulder
PUT-25-3M	25° angles 6 mm Abutment-Body, 3 mm Shoulder

Narrow platform

NL-PUT-1S	4 mm Abutment-Body, 1.1 mm Shoulder
NL-PUT-1M	6 mm Abutment-Body, 1.1 mm Shoulder
NL-PUT-1MC	6 mm Abutment-Body, 0.6 mm Shoulder C= 0.5 mm Vertical Platform switching
NL-PUT-1L	8 mm Abutment-Body, 1.1 mm Shoulder
NL-PUT-1LC	8 mm Abutment-Body, 0.6 mm Shoulder C= 0.5 mm Vertical Platform switching
NL-PUT-2S	4 mm Abutment-Body, 2.1 mm Shoulder
NL-PUT-2SC	4 mm Abutment-Body, 1.1 mm Shoulder C= 1 mm Vertical Platform switching
NL-PUT-2M	6 mm Abutment-Body, 2.1 mm Shoulder
NL-PUT-2MC	6 mm Abutment-Body, 1.1 mm Shoulder C= 1 mm Vertical Platform switching
NL-PUT-2L	8 mm Abutment-Body, 2.1 mm Shoulder
NL-PUT-2LC	8 mm Abutment-Body, 1.1 mm Shoulder C= 1 mm Vertical Platform switching
NL-PUT-3SC	4 mm Abutment-Body, 1.1 mm Shoulder C= 2 mm Vertical Platform switching

All PUT abutments including plastic Cap PUP-CA
and TSA-8.3/NL-TSA-8.3 Titan screw



Impression Analogs

Open and Closed Tray procedure



Implant place holder LAB models

Narrow platform

NL-PUT-3MC	6 mm Abutment-Body, 1.1 mm Shoulder C= 2 mm Vertical Platform switching
NL-PUT-3L	8 mm Abutment-Body, 3.1 mm Shoulder
NL-PUT-3LC	8 mm Abutment-Body, 1.1 mm Shoulder C= 2 mm Vertical Platform switching
NL-PUT-4L	8 mm Abutment-Body, 4.1 mm Shoulder
NL-PUT-15-1M	15° angles 6 mm Abutment-Body, 1 mm Shoulder
NL-PUT-15-2M	15° angles 6 mm Abutment-Body, 2 mm Shoulder
NL-PUT-15-3M	15° angles 6 mm Abutment-Body, 3 mm Shoulder
NL-PUT-25-1M	25° angles 6 mm Abutment-Body, 1 mm Shoulder
NL-PUT-25-2M	25° angles 6 mm Abutment-Body, 2 mm Shoulder
NL-PUT-25-3M	25° angles 6 mm Abutment-Body, 3 mm Shoulder



IA-3.75

Standard Line
Implant Analog
Standard Platform for
3.75 mm, 4.2 mm,
5.0 mm & 6.0 mm



NL-IA-3.0

Narrow Line
Implant Analog Narrow Line
Platform for
3.0 mm and 3.3 mm



TSCT-14

Standard Line, Titanium Screw for
Closed Tray Transfer – 13 mm

NL-TSCT-14

Narrow Line, Titanium Screw for
Narrow Line, Closed Tray Transfer
– 13 mm

TSCT-17

Standard Line, Titanium Screw for
Closed Tray Transfer
– 16 mm

NL-TSCT-17

Narrow Line, Titanium Screw for
Narrow Line, Closed Tray Transfer
– 16 mm

TSOT-24

Standard Line, Titanium Screw for
Open Tray Transfer – 22.8 mm

NL-TSOT-24

Narrow Line, Titanium Screw for
Narrow Line, Open Tray Transfer
– 23.2 mm

TSA-8.3

Standard Line
Titanium Screw 7.6 mm for
straight and angled Abutments

NL-TSA-8.3

Narrow Line, Titanium Screw 7.8 mm
for straight and angled Abutments

Analogs are used by laboratories to replicate the Implant in a plaster model, this is done in order not to use a real Implant for this purpose. There are two types of analogs – Implant level and Abutment level

Since Ritter has two platforms, we only need two Implant Level Analogs – one for the NL/Narrow Line 2.9 Platform and one for the SL/Standard Line 3.75 platform.



Single Unit Prosthetic Components

All Ritter Abutments come with a fixation screw. Single Units have traditionally been manufactured to encompass incremental heights/incremental gingival heights/and Incremental angles - while the crown would compensate/over compensate for intermediary angles/heights and be cemented to the abutment in the mouth.

All Ritter abutments screws are customized to accept the same screw driver - no matter what platform or type of abutment.

Same HEX Driver HHDA
for standard & Narrow Platform
means same Driver/Tool
for abutment fixation



Most Ritter Implants
screws are made of
Grade 5 Titanium!

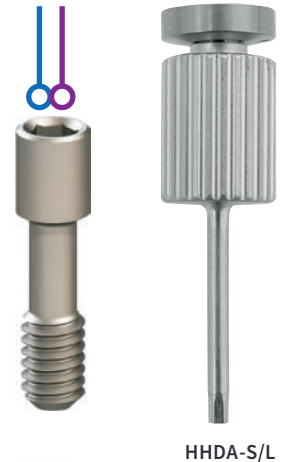

Reason #13

Same abutment
fixation Driver HHDA
for Standard & Narrow Platform

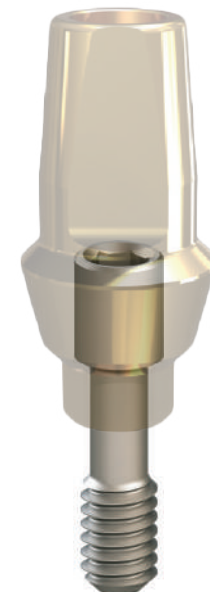

Temporary Abutments

Peek/Titanium



PEEK Abutments Temporary Restoration Abutments



PASA-1

Standard Line
Peek-On anatomical,
straight abutment
1 mm Shoulder,
L 11.1 mm

PASA-2

Standard Line
Peek-On anatomical,
straight abutment
2 mm Shoulder,
L 12.1 mm

PASA-3

Standard Line
Peek-On anatomical,
straight abutment
3 mm Shoulder,
L 13.1 mm

If a dentist is not using our dual Purpose Scan/Temp Abutment, she/he can purchase any of the angles, heights or shoulder heights to make the temporary or provisional crown – Ritter also offers a popular version in Titanium.

Titanium Temporary Abutments



TTA-ZI-H

Temporary-Titanium-Abutment,
Anti-Rotational, \varnothing 4.5 mm
L= 9.5 mm



TTA-ZI-R

Temporary-Titanium-Abutment,
Rotational, \varnothing 4.5 mm
L= 9.5 mm



Anti-Rotational



Rotational

*** NOTICE: NOT ALL ITEMS OF THIS CATALOG ARE APPROVED FOR SALES IN ALL COUNTRIES. PLEASE CHECK THE IMPORT REGULATIONS OF YOUR TERRITORY.***

Abutments for Casting/LAB

Ti-Base with casting sleeves/for LAB use



AZA

Standard Line
Titanium Abutment
with Plastic Sleeve
Titanium base for accurate
restorations.

NL-AZA

Narrow Line
Titanium Abutment
with Plastic Sleeve
Titanium base for accurate
restorations.



AZA-CC

Standard Line
Cobalt Chrome Abutment
with Plastic Sleeve
Cobalt Chrome base for
accurate restorations.

NL-AZA-CC

Narrow Line
Cobalt Chrome Abutment
with Plastic Sleeve
Cobalt Chrome base for
accurate restorations.



AZA-L

Standard Line Long
Titanium Abutment
with Plastic Sleeve

AZA-CC-L

Standard Line Long
Cobalt Chrome Abutment
with Plastic Sleeve



PAC-H

Standard Line
Burn-It Plastic Sleeve
for Laboratory, Anti-Rotational

NL-PAC-H

Narrow Line
Burn-It Plastic Sleeve
for Laboratory,
Anti-Rotational



PAC

Standard Line
Burn-It Plastic Sleeve
for Laboratory, **Rotational**



Reason #14

Ritter's AZA line are made in both Chromium Cobalt and Titanium and are dual purpose as they can be used as Castable with Chromium Cobalt or a Ti-Base made from Titanium.

Ti-Bases/Milling Blanks



Prosthetics Scan Abutments and Ti-Bases

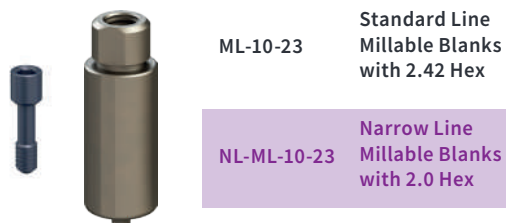

Rotational

Straight Ti-Base

C	0.5 mm	1.5 mm	3 mm
H	4.7 mm	4.7 mm	4.7 mm
Ø	4.2 mm	4.2 mm	4.2 mm
Art. No.	TBC-0.5R	TBC-1.5R	TBC-3R
Narrow Line NL	NL-TBC-0.5R	NL-TBC-1.5R	NL-TBC-3R

As technology has advanced – it has been discovered that cementing should no longer be performed in the mouth – so if you must cement out of the mouth then you need a hole in the crown to cement to the abutment – this was the advent of the “screw retained crown/restoration” and the birth of the Ti-Base. As milling technology became better and cheaper – custom abutments also became very popular – a custom abutment is a more expensive restorative option where the exact angle/height ect of the abutment is made specifically for the patient.

Those who continue to use the stock abutments-cemented out of the mouth – with a screw access whole – refer to this process as screw-mentable. Before there were Ti-Bases and customized abutments there were UCLA and Burn out abutments both were in the category of castable – used to cast gold or other metals into the shape of the custom abutment desired by the lab.

UCLA abutments are traditionally made from Titanium, Gold and Chromium Cobalt. Burn out abutments are made from plastic. For laboratories or Dentists who have titanium milling Machines – Ritter’s ML – Milling blank will be used to make custom titanium abutment.

Anti-Rotational

Straight Ti-Base

C	0.5 mm	1.5 mm	3 mm
H	4.7 mm	4.7 mm	4.7 mm
Ø	4.2 mm	4.2 mm	4.2 mm
Art. No.	TBC-0.5	TBC-1.5	TBC-3
Narrow Line NL	NL-TBC-0.5	NL-TBC-1.5	NL-TBC-3

*** NOTICE: NOT ALL ITEMS OF THIS CATALOG ARE APPROVED FOR SALES IN ALL COUNTRIES. PLEASE CHECK THE IMPORT REGULATIONS OF YOUR TERRITORY***

Titanium Abutments

Preparable Abutments, straight/angled

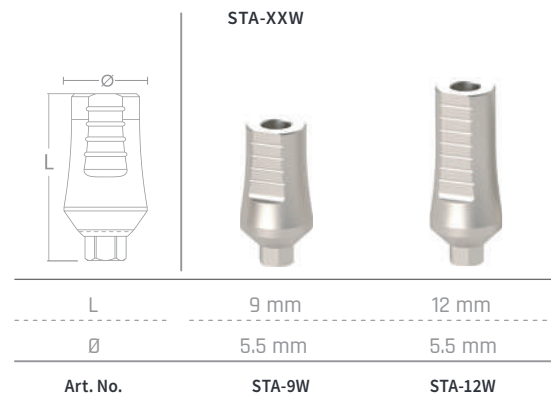
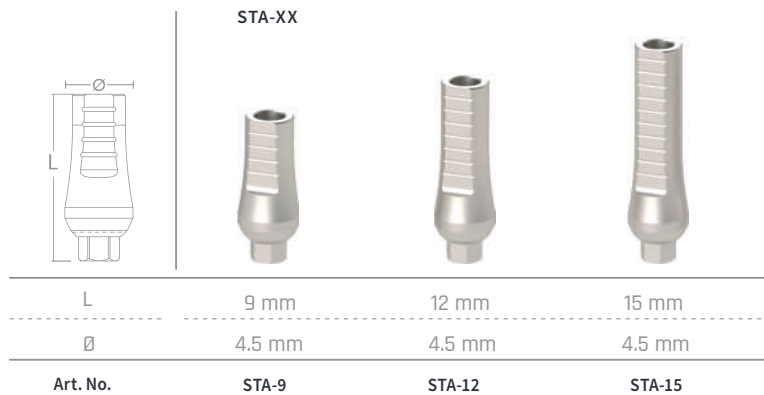
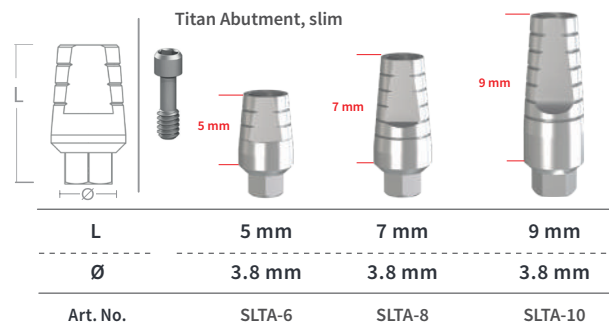
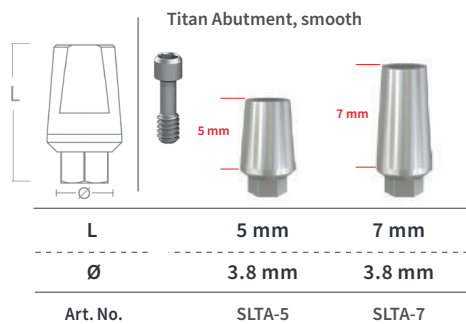

Traditionally these abutments are manufactured to encompass incremental heights, incremental gingival heights and incremental angles - while the crown would compensate/over compensate for intermediary angles/heights and be cemented to the abutment in the mouth. The diameters, heights and shapes are to be decided by the dentist as to prepare and shape the gums for the final crown/prosthesis.



Narrow Line NL
NL-STA-10
Narrow Line
Straight Titanium Abutment
10 mm



Narrow Line NL
NL-ATA-15
15°
Narrow Line
Titanium Abutment
15° Angled

Inkl. TSA-8.3/NL-TSA-8.3 Titanium screw

Also available as STA-5 - L=5 mm and STA-7- L=7 mm

Titanium Abutments

Preparable Abutments, angled



EATA-XX Standard Line – 15° Angled Titanium Abutment
Anatomic Emergency Profile

G1	1 mm	2 mm	3 mm	15°
L	9 mm	10 mm	11 mm	
Art. Nr.	EATA-15-1	EATA-15-2	EATA-15-3	

Incl. TSA-8.3 Titanium screw

EATA-XX Standard Line – 25° Angled Titanium Abutment
Anatomic Emergency Profile

G1	1 mm	2 mm	3 mm	25°
L	9 mm	10 mm	11 mm	
Art. Nr.	EATA-25-1	EATA-25-2	EATA-25-3	

Incl. TSA-8.3 Titanium screw

L	9 mm	9 mm	25°
Art. Nr.	ATA-25N	ATA-25	

Incl. TSA-8.3 Titanium screw

Titanium Abutments

Preparable Abutments, straight



SATA-X, Standard Line, straight Anatomic Emergency Profile Titanium Abutment

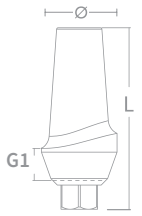

G1	1 mm	2 mm	3 mm
L	8.9 mm	9.9 mm	10.9 mm
Ø	4.5 mm	4.5 mm	4.5 mm
Art. No.	SATA-1	SATA-2	SATA-3



All Abutments are supplied with TSA-8.3 Implant Level Screw OR for NL Line with NL-TSA-8.3 screw

SSTA-XX Standard Line – Straight Titanium Abutment Traditional Emergency Profile

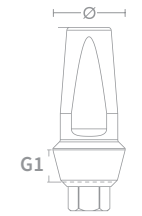

G1	1 mm	2 mm	3 mm	4 mm
Ø	4.8 mm	4.8 mm	4.8 mm	4.8 mm
Art. No.	SSTA-1	SSTA-2	SSTA-3	SSTA-4
Narrow Line NL	NL-SSTA-1	NL-SSTA-2	NL-SSTA-3	

ESPS-XX Standard Line – Straight Titanium Abutment, Emergency Profile

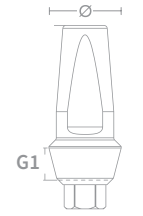

G1	1 mm	2 mm	3 mm
Ø	4.8 mm	4.8 mm	4.8 mm
Art. No.	ESPS-1	ESPS-2	ESPS-3

Narrow Line – Straight Titanium Abutment – X mm Shoulder

ABU

Across Brand Usability



Ritter Implants system has ABU with many other brands:



AB Dental
Adin
Alfa
Alpha Bio
Alpha Dent
Astra Tech
Axelmed
BEGO
Biohorizons
Cortex
Dentegris
Dentium
Dio
Ditron
Edison Medical
Hiossen
Implant Direct
iRes

JDentalCare
MegaGen
MIS
NeoBiotec
Nobel Biocare
Noris Medical
Osstem
Oxy
Paltop
Ritter Implants
SGS Dental
Spiral Tech
Straumann
Surgikor
TAG
TAV Dental
TRI Dental Implants AG
Zimmer



Overdenture Abutments

Overdenture abutments are simply abutments to anchor dentures to Implants. There are several types but they can be broken into two categories – removable and fixed.

Removable can be removed and replaced by the patient – simply snapping the denture into place, and unsnapping it whenever they want.

Fixed can only be removed by the Dentist and are mainly retained with screws.



Ball Attachments and Accessories



As shown, ball attachments are screwed into the Implant to hold a denture in place – they were the first products invented to hold a denture in the mouth without glue. A metal cap is placed and imbedded into the plastic denture – aligning with the location of where the ball attachment will protrude from the Implant. The polyamide inserts are simply shock absorbers. These products were originally designed to place 2 implants on each side of the mouth.

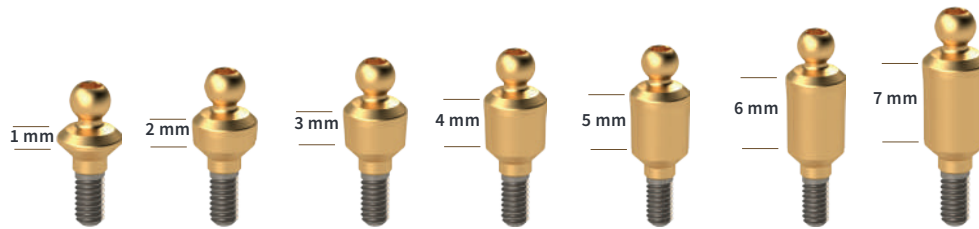

Art. No.	BA-1	BA-2	BA-3	BA-4	BA-5	BA-6	BA-7
----------	------	------	------	------	------	------	------

Narrow Line NL	NL-BA-1	NL-BA-2	NL-BA-3	NL-BA-4
----------------	---------	---------	---------	---------

Description Ball-Attachment, Titanium nitride coated, incl. 1 SCB-P, 1 BA-SP, 1 – MCB Metal Cap

NL = Narrow Line for 3.0 & 3.3 mm ϕ Implants



Art. No.	SCB-T	SCB-P	SCB-Y	SCB-G	SCB-B	BA-SP	MCB
----------	-------	-------	-------	-------	-------	-------	-----

+++ REPLACEMENT KITS OF CAPS WILL COME BY 4 PCS. THE MCB METAL CAP COMES SINGLE PACKED +++



BA-X comes with 3 components – the caps are inserted in the full arch overdenture.
 1 BA-X
 1 SCB-P,
 1 MCB Metal Cap



Polyamide Caps for Ball Attachment (SCB)

- SCB-T: Transparent (4 pcs.): slightly elastic, retention 2.5–2.9 lbs (1.13–1.32 kg)
- SCB-P: Pink (4 pcs.): elastic, retention 1.75–2.0 lbs (0.79–0.90 kg) - **STANDARD INCLUDED**
- SCB-Y: Yellow (4 pcs.): very elastic, retention 1.0–1.3 lbs (0.45–0.6 kg)
- SCB-G: Green (4 pcs.): extremely elastic, retention <1 lbs (<0.45 kg)
- SCB-B: Black (4 pcs.): for laboratory use only
- BA-SP: Separator O-Rings for Ball Attachment and Clicq™ Overdenture
- MCB: Metal Insert cap for Ball Attachment Prosthesis

Overdenture Abutments

Removable LOCATOR® System by ZEST®

LOCATOR® R-Tx



In 1972 The Zest Locator Company perfected the Overdenture Abutment and patented the Locator. The original Locator was proven to provide better retention than the ball attachment and remains the most popular overdenture abutment in the world. They use the same principle as the ball attachment with a metal cap and silicon inserts for cushioning. We do not make these so the screw driver is different. Also Note it is expensive and all parts are sold separately. In Recent years the Zest Corporation has launched two new versions of the Locator.

In an effort to offer a wider range of angle correction they produced the R-TX. The top portion of the abutment allows the metal housing to swivel. The thought was they could give the same retention and allow for greater angulation in Implant placement.

*** They really needed to make an angled version, but made this option instead.

Art. No.	LOCATOR R-TX ATTACHMENT SYSTEM	Art. No.	LOCATOR R-TX ATTACHMENTS & ACCESSORIES
31500-04-SB	LOCATOR R-TX Attachment System, 3.0 mm Internal Hex Connection, 4.0 mm Cuff	30002-01	LOCATOR R-TX Low Retention Insert, Blue, Includes 4
30200-00-SB	LOCATOR R-TX Attachment System, 3.5 mm Internal Hex Connection, 0.5 mm Cuff	30003-01	LOCATOR R-TX Medium Retention Insert, Pink, Includes 4
30200-01-SB	LOCATOR R-TX Attachment System, 3.5 mm Internal Hex Connection, 1 mm Cuff	30004-01	LOCATOR R-TX High Retention Insert, Clear, Includes 4
30200-02-SB	LOCATOR R-TX Attachment System, 3.5 mm Internal Hex Connection, 2 mm Cuff	30021-01	LOCATOR R-TX Retention Insert Tool
30200-03-SB	LOCATOR R-TX Attachment System, 3.5 mm Internal Hex Connection, 3 mm Cuff	30053-01	LOCATOR R-TX 4x Macro Model
30200-04-SB	LOCATOR R-TX Attachment System, 3.5 mm Internal Hex Connection, 4 mm Cuff		
30200-05-SB	LOCATOR R-TX Attachment System, 3.5 mm Internal Hex Connection, 5 mm Cuff		

Removable LOCATOR® Attachment System

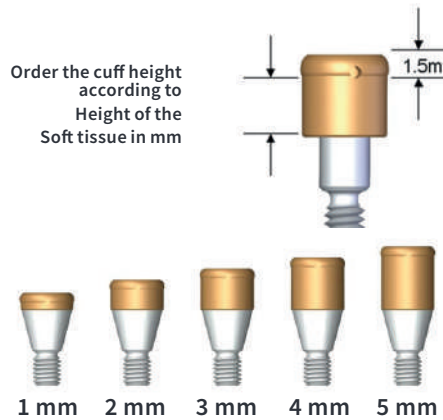

Measurement for the height of the tissue sleeve: The height of the LOCATOR® Tissue Cuff ranges from 1–5 mm (platform to the bottom of the 1.5 mm coronal section).

The upper section, 1.5 mm of each locator is the same. The transition to the platform (EN) and the connection is different.

Interocclusal distance:
Less than 3.2 mm for external hex and 2.5 mm for implants with internal connection (with 0 mm cuff height).



Bar:

08026



Yellow at Bar constructions



Denture insert
08510-RT-SB

Standard Line:

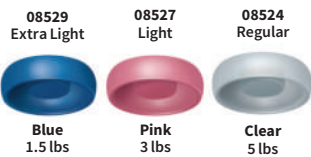

0–10° Angle

Extended Line:



> 10° Angle to 20° per Implant

Art. No.	LOCATOR® ABUTMENTS for Ritter Implants
02284-RT-SB	LOCATOR Abutment 1.0 mm Cuff for Ritter Implants Standard Platform
02285-RT-SB	LOCATOR Abutment 2.0 mm Cuff for Ritter Implants Standard Platform
02286-RT-SB	LOCATOR Abutment 3.0 mm Cuff for Ritter Implants Standard Platform
02287-RT-SB	LOCATOR Abutment 4.0 mm Cuff for Ritter Implants Standard Platform
02288-RT-SB	LOCATOR Abutment 5.0 mm Cuff for Ritter Implants Standard Platform
NL-02308-RT-SB	LOCATOR Abutment for intern. Hex Ø: 3 mm, Cuff: 0.75 mm, final packing
NL-02309-RT-SB	LOCATOR Abutment for intern. Hex Ø: 3 mm, Cuff: 2 mm, final packing
NL-02310-RT-SB	LOCATOR Abutment for intern. Hex Ø: 3 mm, Cuff: 3 mm, final packing
NL-02311-RT-SB	LOCATOR Abutment for intern. Hex Ø: 3 mm, Cuff: 4 mm, final packing
NL-02312-RT-SB	LOCATOR Abutment for intern. Hex Ø: 3 mm, Cuff: 5 mm, final packing
NL-02313-RT-SB	LOCATOR Abutment for intern. Hex Ø: 3 mm, Cuff: 5 mm, final packing
NL-02313-RT-SB	LOCATOR Abutment for intern. Hex Ø: 3 mm, Cuff: 6 mm, final packing
NL = Narrow Line for 3.0 & 3.3 mm Ø Implants	

Art. No.	LOCATOR® ABUTMENTS for Ritter Implants
08393-RT-SB	LOCATOR Core Tool
08390-RT-SB	LOCATOR Abutment Driver, gold
08519-2-RT-SB	LOCATOR Plug Processing Set, 4 Pieces
08505-RT-SB	LOCATOR Impression Coping, 4 Pieces
08510-RT-SB	LOCATOR Replacement Denture Cap, Metal, 4 Pieces
08530-RT-SB	LOCATOR Analogs 4 mm Ø, 4 Pieces
08519-10-RT-SB	Male Processing Package, Includes 10
08524-RT-SB	LOCATOR Denture Cap, clear, 4 Pieces
08527-RT-SB	LOCATOR Denture Cap, light adhesion, pink, 4 Pieces
08529-RT-SB	LOCATOR Denture Cap, extra light adhesion, blue, 4 Pieces
08547-RT-SB	LOCATOR Denture Cap, green, 4 Pieces
08915-RT-SB	LOCATOR Denture Cap, orange, 4 Pieces
08548-RT-SB	LOCATOR Denture Cap, extra light adhesion, red, 4 Pieces
08558-RT-SB	LOCATOR Denture Cap, no adhesion, gray, 4 Pieces
08517-RT-SB	LOCATOR Parallel Post, 4 Pieces
08515-RT-SB	LOCATOR Black Plug Processing Set, 4 Pieces
09530-RT-SB	LOCATOR Angle measurement guide
09566-RT-SB	Chairside Attachment Processing Material
08260-RT-SB	LOCATOR 35 Ncm Torque Screwdriver, 15 mm

Removable Overdenture Abutments

Clicq™

The Clicq™ overdenture is known around the world as an Equator – this type of product was produced to compete with the Original Zest Locator without violating their patents.

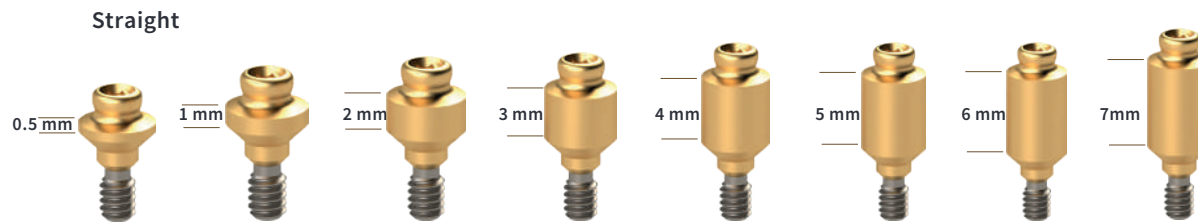

Art. No.	COD-0.5	COD-1	COD-2	COD-3	COD-4	COD-5	COD-6	COD-7
Narrow Line NL	NL-COD-0.5	NL-COD-1	NL-COD-2	NL-COD-3	NL-COD-4	NL-COD-5	NL-COD-6	

Description Clicq™ Set: Titanium nitride coated, incl. SCL-T, SCL-P, SCL-Y, SCL-B, 1 - BA-SP, 1 - MC-COD



Reason #15/16/17

- More narrow profile #15
- Angled Versions available #16
- All the processing parts included #17

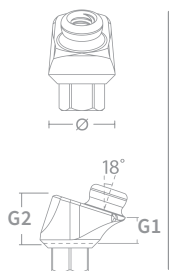

Angled Clicq™ 18° – K=Kit

Included TSAMU, NL-TSAMU Screw

18°



G2	2.5 mm	3.5 mm	4.5 mm	5.5 mm
G1	1 mm	2 mm	3 mm	4 mm
∅	3.85 mm	3.85 mm	3.85 mm	3.85 mm

Art. No.	COD-18-1	COD-18-2	COD-18-3	COD-18-4
Narrow Line NL	NL-COD-18-1	NL-COD-18-2	NL-COD-18-3	NL-COD-18-4

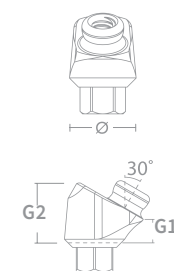

Angled Clicq™ 30° – K=Kit

Included TSAMU, NL-TSAMU Screw

30°



G2	3.5 mm	4.5 mm	5.5 mm	6.5 mm
G1	1 mm	2 mm	3 mm	4 mm
∅	3.85 mm	3.85 mm	3.85 mm	3.85 mm

Art. No.	COD-30-1	COD-30-2	COD-30-3	COD-30-4
Narrow Line NL	NL-COD-30-1	NL-COD-30-2	NL-COD-30-3	NL-COD-30-4

Removable Overdenture Abutments

Clicq™/Analog and Accessories

Content of the COD-X KIT includes:

- 1 x COD-X (size)
- 4 x SCL Retentive Caps, each B/Y/P/T
- 1 x MC COD Metal Housing
- 1 x BA-SP Disk

Clicq™ Analog Abutment

L	12.3 mm
∅	3.8 mm
Art. No.	COD-IA

Clicq™ Pick-Up Impression Transfer

L	5.6 mm
∅	4.6 mm
Art. No.	COD-PIT

Clicq™ Impression Transfer

L	3.7 mm
∅	8.7 mm
Art. No.	COD-IT

Clicq™ Protective Disk (4 pcs/pack)

∅1	8 mm
∅2	2 mm
Art. No.	BA-SP

Clicq™ Metal Housing (2 pcs/pack)

L	2 mm
∅	4.5 mm
Art. No.	MC-COD

Clicq™ Retentive Cap (4 pcs/pack)

	Lab use only Black laboratory	Ex-Soft Yellow	Soft Pink	Standard Transparent	Strong Violet
L	1.7 mm	1.7 mm	1.7 mm	1.7 mm	1.7 mm
∅	3.8 mm	3.8 mm	3.8 mm	3.8 mm	3.8 mm
Art. No.	SCL-B	SCL-Y	SCL-P	SCL-T	SCL-V

+++ REPLACEMENT KITS OF CAPS WILL COME BY 4 PCS. THE MC-COD METAL CAP COMES SINGLE PACKED +++

Insertion & Extraction Tool for Overdenture Attachments
Suitable for all Overdenture Lines

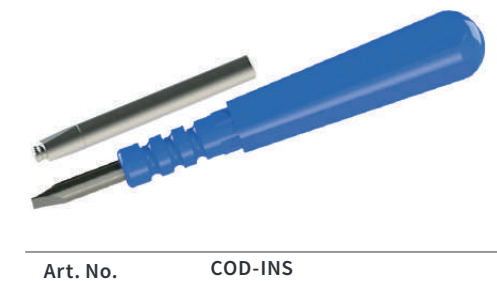

Removable Overdenture Abutments

Clicq™ PLUS

The Clicq™ Overdenture Plus was created for the Dentist to have a wider option of the Abutment- this has the Same Principle purpose as Ball Attachments, Zest Locator, and Clicq™. More than one option for angled Overdenture abutments is makes Ritter unique.



Reason #18



G	0.5 mm	1 mm	2 mm	3 mm	4 mm	5 mm	6 mm	7 mm
Ø	4.1 mm	4.1 mm	4.1 mm	4.1 mm	4.1 mm	4.1 mm	4.1 mm	4.1 mm

Art. No.	COD-0.5P	COD-1P	COD-2P	COD-3P	COD-4P	COD-5P	COD-6P	COD-7P
----------	----------	--------	--------	--------	--------	--------	--------	--------

Narrow Line NL	NL-COD-0.5P	NL-COD-1P	NL-COD-2P	NL-COD-3P	NL-COD-4P	NL-COD-5P	NL-COD-6P	NL-COD-7P
----------------	-------------	-----------	-----------	-----------	-----------	-----------	-----------	-----------

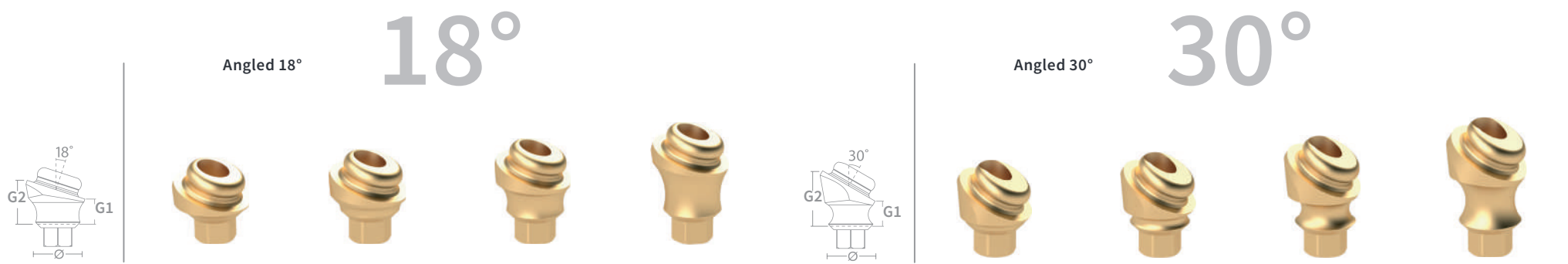

G2	2.1 mm	2.6 mm	3.6 mm	4.6 mm	G2	3.1 mm	3.6 mm	4.6 mm	5.6 mm
G1	0.5 mm	1 mm	2 mm	3 mm	G1	0.5 mm	1 mm	2 mm	3 mm
Ø	5.2 mm	5.2 mm	5.2 mm	5.2 mm	Ø	5.2 mm	5.2 mm	5.2 mm	5.2 mm

Art. No.	COD-18-0.5P	COD-18-1P	COD-18-2P	COD-18-3P	Art. No.	COD-30-0.5P	COD-30-1P	COD-30-2P	COD-30-3P
----------	-------------	-----------	-----------	-----------	----------	-------------	-----------	-----------	-----------

Narrow Line NL	NL-COD-18-0.5P	NL-COD-18-1P	NL-COD-18-2P	NL-COD-18-3P	Narrow Line NL	NL-COD-30-0.5P	NL-COD-30-1P	NL-COD-30-2P	NL-COD-30-3P
----------------	----------------	--------------	--------------	--------------	----------------	----------------	--------------	--------------	--------------



Removable Overdenture Abutments

Clicq™ PLUS/Analog and Accessories

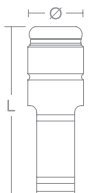

Content of the COD-XP KIT includes:

- 1x COD-XP (size)
- 4 x SCLP Retentive Caps, each B/Y/P/T
- 1x MC-CODP Metal Housing
- 1x CODP-SP Disk



Clicq™ Analog Abutment

	
L	12.3 mm
Ø	3.8 mm
Art. No.	COD-IA

Clicq™ Pick-Up Impression Transfer





	
L	5.6 mm
Ø	4.6 mm
Art. No.	COD-PIT

Clicq™ Metal Housing (2 pcs/pack)



	
L	2 mm
Ø	4.5 mm
Art. No.	MC-CODP



Clicq™ Retentive Cap (4 pcs/pack)

	Lab use only Black laboratory	Ex-Soft Yellow	Soft Pink	Standard Transparent	Strong Violet
					
L	1.7 mm	1.7 mm	1.7 mm	1.7 mm	1.7 mm
Ø	3.8 mm	3.8 mm	3.8 mm	3.8 mm	3.8 mm
Art. No.	SCLP-B	SCLP-Y	SCLP-P	SCLP-T	SCLP-V

Clicq™ Protective Disk (4 pcs/pack)

	
Ø1	8 mm
Ø2	2 mm
Art. No.	CODP-SP

Insertion & Extraction Tool for Overdenture Attachments
Suitable for all Overdenture Lines



Art. No. COD-INS

+++ REPLACEMENT KITS OF CAPS WILL COME BY 4 PCS. THE MC-CODP METAL CAP COMES SINGLE PACKED +++



Reason #22

Ritter Implants were the first to transition a patient from a removable Denture to an “all on X”. Why?

Because a removable case can be planned with the “Angled Clicq™” Abutments.

Screw Receiving Multi Unit Abutments

Multi Unit Abutments (MUA) were created by Nobel Biocare[®] for the concept of replacing all teeth with a full porcelain or Zirconia Bridge instead of a plastic Denture over 4 Implants. This procedure was called “All on 4[®]”.

This procedure involved at least placing two posterior Implants at a minimum of at least a **17 Degree angle** and **2 more at any angle**. The angulation is required for cross arch stability.

It is now known to be called **all on X** because **6–8 Implants** are now being used.

Multi unit abutments are designed so that the teeth (denture/bridge/prosthesis) can be removed without removing the actual abutments from the implants.

They are similar to the overdenture principle in that a part must be fused or cemented into the prosthesis just like the metal housing in an overdenture. However the attachments for Multi units are traditionally titanium cylinders with screw access holes – these parts are screwed into the multi unit abutments instead of being snapped onto overdenture abutments.

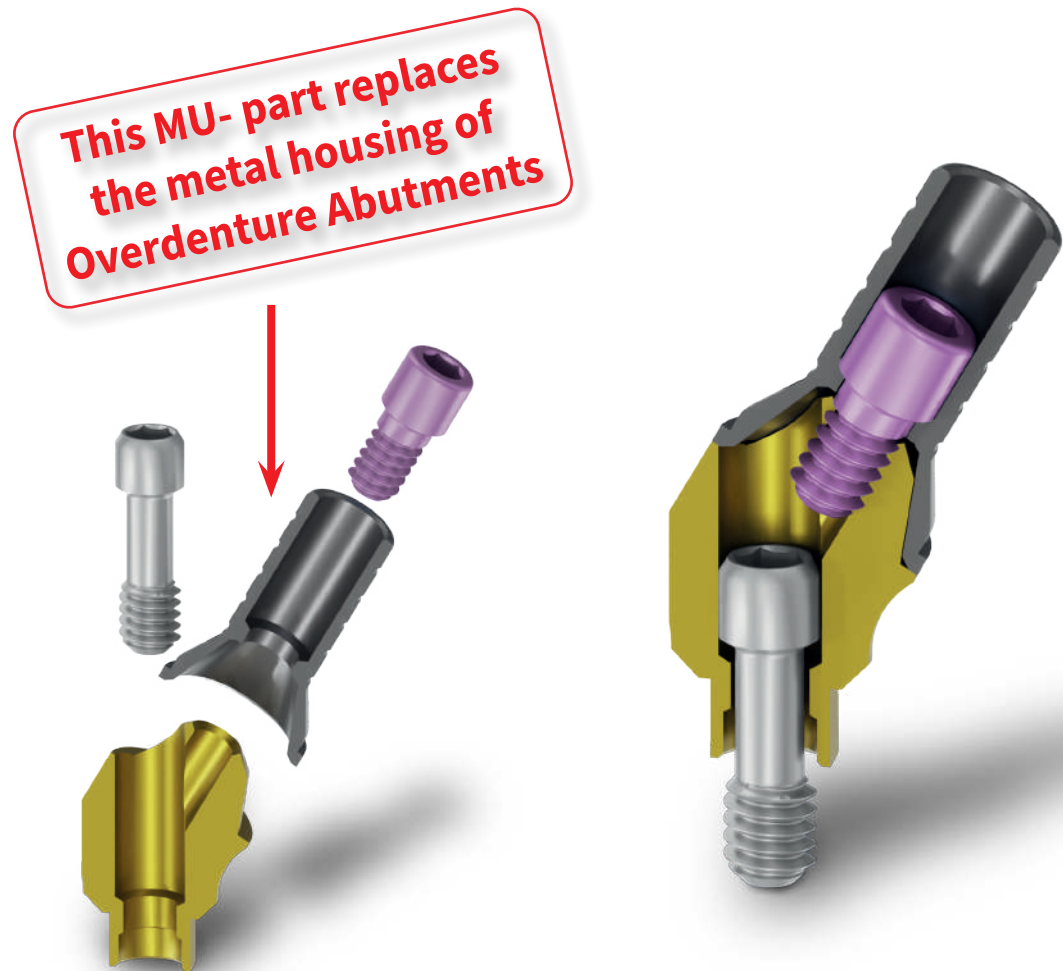

Screw Receiving Multi Unit Abutments













One Piece Multi-Unit Abutments, straight and angled Multi-Unit KS-System

Ritter Multi Abutments have been manufactured with a wider stronger M1.6 screw instead of a M1.4 screw that most companies use on Multi unit restorations. Ritter offers this packaged with very commonly used accessories making it simple for a dentist to order parts.

#19 Ritter makes this for its 3.0 and 3.3 Narrow line platform #20 and most companies narrow platform are strong enough to support this type of abutment on such narrow Implants.



Reason #19,20

		17°			30°			
	MU-KS10 NL-MU-KS10	Standard Line Straight Multi Unit 1 mm Shoulder		MU-KS1710 NL-MU-KS1710	Standard Line 17° angled Multi Unit 1.1 mm/2.5 mm Shoulder (G1/G2)		MU-KS3010 NL-MU-KS3010	Standard Line 30° angled Multi Unit 1.1 mm/3.5 mm Shoulder (G1/G2)
	MU-KS20 NL-MU-KS20	Standard Line Straight Multi Unit 2 mm Shoulder		MU-KS1720 NL-MU-KS1720	Standard Line 17° angled Multi Unit 2.1 mm/3.5 mm Shoulder (G1/G2)		MU-KS3020 NL-MU-KS3020	Standard Line 30° angled Multi Unit 2.1 mm/4.5 mm Shoulder (G1/G2)
	MU-KS30 NL-MU-KS30	Standard Line Straight Multi Unit 3 mm Shoulder		MU-KS1710H	Standard Line 17° angled Multi Unit 1.1 mm/2.5 mm Shoulder (G1/G2) with Anti-rotation		MU-KS3010H	Standard Line 30° angled Multi Unit 1.1 mm/3.5 mm Shoulder (G1/G2) with Anti-rotation
	MU-KS40 NL-MU-KS40	Standard Line Straight Multi Unit 4 mm Shoulder		MU-KS1720H	Standard Line 17° angled Multi Unit 2.1 mm/3.5 mm Shoulder (G1/G2) with Anti-rotation		MU-KS3020H	Standard Line 30° angled Multi Unit 2.1 mm/4.5 mm Shoulder (G1/G2) with Anti-rotation

Also available:
MU-KS50, NL-MU-KS50

Also available:
MU-KS1730, NL-MU-KS1730
MU-KS1740, NL-MU-KS1740

Also available:
MU-KS3030, NL-MU-KS3030
MU-KS3040, NL-MU-KS3040

Screw Receiving Multi Unit Abutments

One Piece Multi-Unit Abutments, straight and angled Multi-Unit KS-System



Multi Unit Sets/Kits including all necessary components=K

	MU-KS10K Multi Unit Kit 1 mm Shoulder height NL-MU-KS10K
	MU-KS20K Multi Unit Kit 2 mm Shoulder height NL-MU-KS20K
	MU-KS30K Multi Unit Kit 3 mm Shoulder height NL-MU-KS30K
	MU-KS40K Multi Unit Kit 4 mm Shoulder height NL-MU-KS40K

Also available:
MU-KS50K, **NL-MU-KS50K**

17° 	MU-KS1710K 17° angled Multi Unit Kit 1 mm/2.4 mm Shoulder height (G1/G2) NL-MU-KS1710K
	MU-KS1720K 17° angled Multi Unit Set 2 mm/3.3 mm Shoulder height (G1/G2) NL-MU-KS1720K
30° 	MU-KS3010K 30° angled Multi Unit Kit 1 mm/3.3 mm Shoulder height (G1/G2) NL-MU-KS3010K
	MU-KS3020K 30° angled Multi Unit Kit 2 mm/4.4 mm Shoulder height (G1/G2) NL-MU-KS3020K

Also available:
MU-KS1730K, **NL-MU-KS1730K**, MU-KS1740K, **NL-MU-KS1740K**
MU-KS3030K, **NL-MU-KS3030K**, MU-KS3040K, **NL-MU-KS3040K**

Multi Unit Set Components

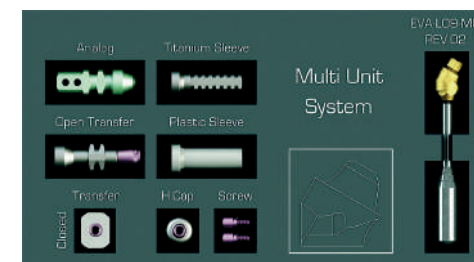

Includes: Healing Cap, open and closed Transfer, Plastic Sleeve, Titanium Sleeve, Analog & 2 Screws

- 1x MU-KSxxxx Multi Unit Abutment
- 1x MU-KSTST Screw
- 1x MU-KSOTT open impression
- 1x MU-KSPT closed impression
- 1x MU-KSAN Analog Abutment
- 1x MU-KSHC Healing cap
- 1x MU-KSSLP Plastic sleeve
- 1x MU-KSSL Titanium sleeve
- 2x MU-KSTS Screw

Note: Illustration for display purposes only. The items are supplied in blister packaging. In some Countries items can be supplied in the Kit/Tray above.

Includes TSAMU Titanium Screw for one piece angled Multi Unit
Includes MU-KSTS Titanium Screw & MU-HD Holder for one piece angled Multi Unit

Screw Receiving Multi Unit Abutments

One Piece Multi Unit Abutments, straight and angled Multi Unit KS-System
Accessories



MU-KSAN
Analog Abutment for
Multi Unit KS System
(Cone with M 1.6 X 0.35)



MU-KSPT
Closed Plastic Transfer for
Multi Unit KS System
(Assembled with MU-KSTS Titanium
Screw MU-KSPTB Basis for closed
Transfer)



The accessories are all used for the descriptions previously shown in Single units but are all **ABUTMENT LEVEL ACCESSORIES** and can only be used for Ritter MUA.



MU-KSOTT
Open Transfer for
Multi Unit KS System
(MU-KSTSOT
Titanium Screw included)



MU-KSTS
Titanium Screw for
Multi Unit Cone **ABUTMENT LEVEL**
M 1.6 X 0.35 - KS System



MU-KSHC
Healing Cap for
Multi Unit KS System
(Assembled with
MU-KSTS Titanium Screw)

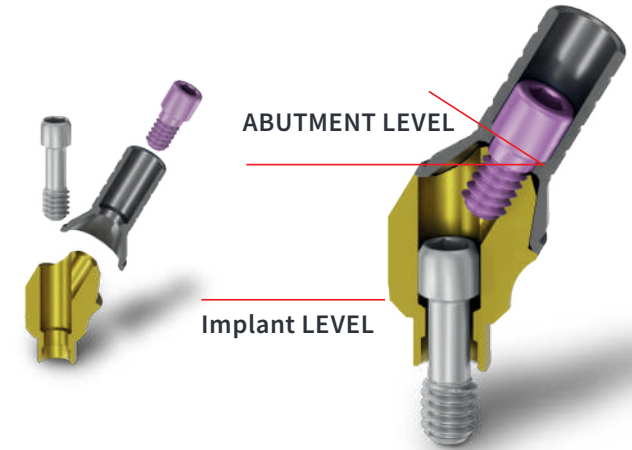

MU-KSSL
Titanium Sleeve for
Multi Unit KS System
(MU-KSTST includes)



MU-KSSLP
Plastic Sleeve for
Multi Unit KS System
(MU-KSTS
Titanium Screw includes)



MU-KSAC-R
Prosthetic Cap, rotating
(MU-KSTS Titanium Screw includes)



MU-KSAC-AR
Prosthetic Cap, non-rotating
For single restoration
(MU-KSTS Titanium Screw includes)

Screw Receiving Multi Unit Abutments

One Piece Multi Unit Abutments, straight and angled Multi-Unit KS-System



Multi Unit Professional Kit Parts:

Accessories Included

Item Code	Description	QTY
MU-KSAN	Analog Abutment	6
MU-KSOTT	Open Tray Transfer	6
MU-KSSL	Titanium Sleeve	6
MU-KSPT	Closed Tray Transfer	6
MU-KSHC	Healing Cap Includes Screw	6
MU-KSSLP	Plastic Sleeve	6
MU-KSAC-R	Rotational Adhesive Cap	2
MU-KSAC-AR	Anti Rotational Adhesive Cap	2
MU-KSTS	Screw for Cone Connection	10
HHDA	Screw Driver	1
MU-KSSB	Scan Body	1

Abutments Included

Includes Screw MU-KSTS and Carrier MU-HD not sold individually:

Item Code	QTY	Also available in Narrow Line NL
MU-KS10	4	NL-MU-KS10
MU-KS20	4	NL-MU-KS20
MU-KS30	4	NL-MU-KS30
MU-KS40	4	NL-MU-KS40
MU-KS50	4	NL-MU-KS50
MU-KS1710	3	NL-MU-KS1710
MU-KS1720	3	NL-MU-KS1720
MU-KS1710H	1	NL-MU-KS1710H
MU-KS1720H	1	NL-MU-KS1720H
MU-KS3010	3	NL-MU-KS3010
MU-KS3020	3	NL-MU-KS3020
MU-KS3010H	1	NL-MU-KS3010H
MU-KS3020H	1	NL-MU-KS3020H

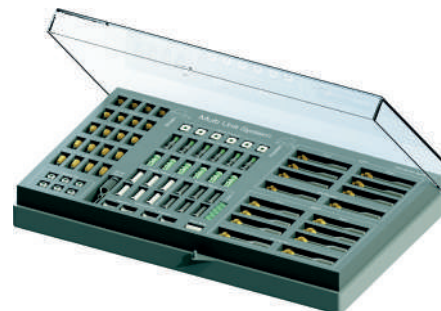

***** NOTICE: NOT ALL ITEMS OF THIS CATALOG ARE APPROVED FOR SALES IN ALL COUNTRIES. PLEASE CHECK THE IMPORT REGULATIONS OF YOUR TERRITORY.*****

This special Kit Comes with **36 Abutments** so the doctor does not have to open several packages – this makes complicated procedure much easier!



Reason #21

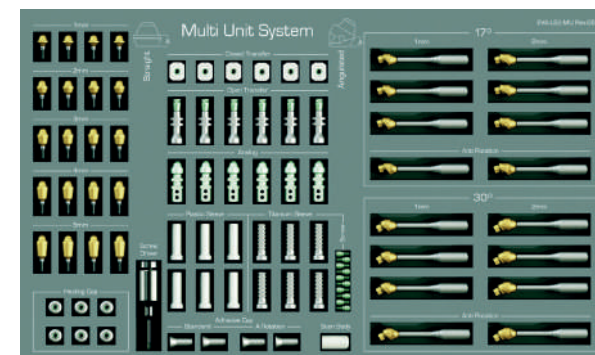

Biologics

Bone Graft Materials

Only Available in the US for Domestic Non-Laboratory or Research Use

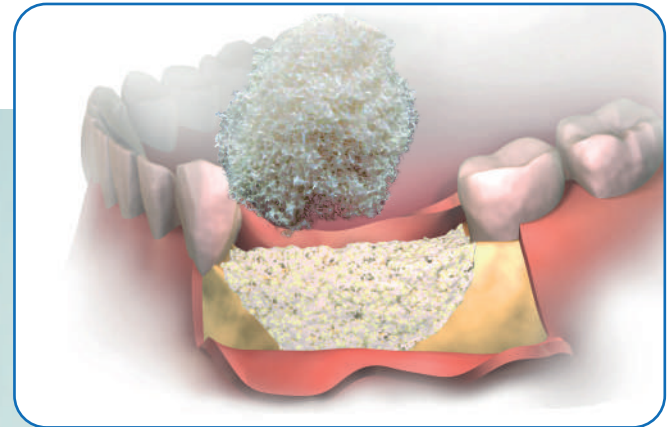



Biologics

DentalFix™ Dental Bone Particulate

Only Available in the US for Domestic Non-Laboratory or Research Use



Image	Item No.	Description
	423202	0.25 cc
	423205	0.5 cc
	423210	1.0 cc
	423220	2.0 cc
	423250	5.0 cc
	423002	0.25 cc
	423005	0.5 cc
	423010	1.0 cc
	423020	2.0 cc
	423050	5.0 cc
	423102	0.25 cc
	423105	0.5 cc
	423110	1.0 cc
	423120	2.0 cc
	423150	5.0 cc



DentalFix™ regenerative implants provide quality grafting solutions for the informed clinician.

Reliable grafting options are available in the form of DBM putty, dermis, Matrix OI® FlexIT, Matrix OI®, demineralized and mineralized cortical and cancellous grafts, including particulate bone, for optimal long-term osteointegration and esthetic results. Clinicians can avoid the need for clinically challenged secondary surgical site autografts associated morbidity by using CellRights DentalFix™ products.

Technologies® validated BioRinse™ sterilization process uses proprietary rinsing agents in multiple combinations designed to kill pathogenic microorganisms, vegetative bacteria and spores. These steps include the removal of debris, blood, bone marrow, and lipids. The BioRinse™ process is a technologically advanced science developed for use in all product families including osteoinductive in-vivo verified Matrix OI® family of products. BioRinse™, in combination with our final sterilization step, ensures a medical device sterility assurance level (SAL 10⁻⁶) for all CellRight products.



The grafts should be stored in ambient temperatures (59-86°F or 15-30°C).

DentalFix™ implants are currently used in oral regenerative procedures including:

- periodontal defects
- tunnelling soft tissue augmentation
- sinus augmentation
- extraction socket with partial Buccal wall
- socket extraction procedures
- repair of 3-wall defects
- repair to access windows
- sinus-lift with lateral access & lateral ridge augmentation

Elongated particle design for maximum surface area
 Indications for use: sinus and ridge augmentation, socket preservation, bone void filling.

- Mineralized cortical particulate - jar
- Mineralized cancellous particulate - jar
- Mineralized cortical/cancellous particulate - jar
- Five year shelf life
- Sterility assurance level (SAL) of 10⁻⁶

Biologics

MatrixOI® FlexIT

Only Available in the US for Domestic Non-Laboratory or Research Use

Image	Item No.	Description
	446001	10 x 10 mm
	446002*	15 x 10 mm
	446003	15 x 15 mm
	446004*	20 x 20 mm
	446005	30 x 30 mm
	446006*	50 x 25 mm
	446007	17 x 10 mm

* Available upon request, not available online.

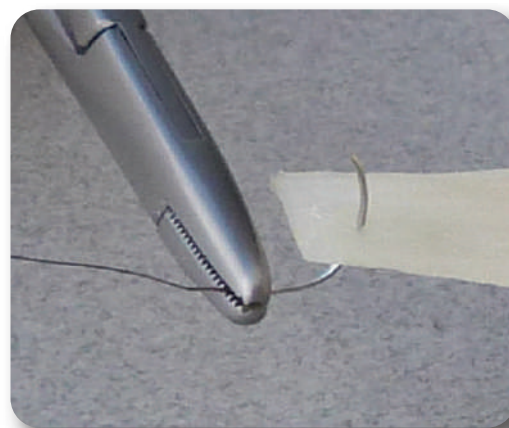

Matrix OI® FlexIT, when hydrated, is a thin pliable cortical sheet that has the ability to be sized with scissors or a scalpel.

To accelerate graft reconstitution, submerge the Matrix OI® FlexIT in luke warm water or saline for 10-30 minutes and manipulate periodically, especially for larger size grafts. Graft pliability may occur sooner than 10-30 minutes.

Matrix OI® products are verified for osteoinductivity prior to release for distribution. In-vivo Matrix OI® test results demonstrate all five (5) bone-forming elements present (Chondrocytes, Osteocytes, Bone Marrow, Cartilage, and

New Bone). In-vitro Matrix OI® test results for BMP levels demonstrate Matrix OI® products have up to 19x the native BMP levels of the BMP-2 control.

The grafts are freeze-dried and sterilized using low-dose gamma irradiation to achieve a sterility assurance level (SAL) of 10⁻⁶. The grafts should be stored in ambient temperatures (59-86°F or 15-30°C) and have a shelf-life of up to five (5) years from the date of packaging.

Our proprietary next-generation BioRinse™ processing technology has been proven to preserve native bone morphogenic proteins (BMP's).

Matrix OI® FlexIT is indicated for use in craniomaxillofacial applications including cranial repair, orbital floor, and zygomatic fractures, involving sutures, plates, anchors, and other fixation devices. Other uses for Matrix OI® FlexIT include acetabular reconstruction, posterolateral spinal procedures, long-bone fracture plate, non-unions, and dental procedures.

Biologics

MatrixCollect® 100 DBM Putty

Only Available in the US for Domestic Non-Laboratory or Research Use



Image	Item No.	Description
	452005	0.5 cc
	452010	1.0 cc
	452025	2.5 cc
	452050*	5.0 cc
	452075*	7.5 cc
	452100*	10 cc

* Available upon request, not available online.

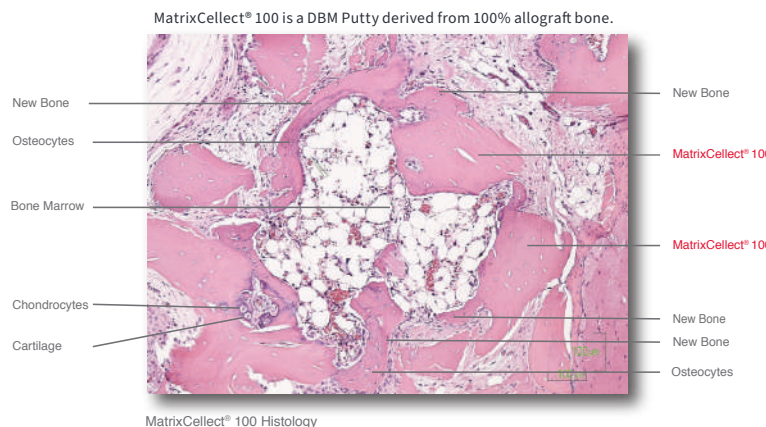

MatrixCollect® 100 is a 100% DBM putty processed using our proprietary demineralization process. MatrixCollect® 100 has been histologically proven post sterilization to exhibit five elements of bone formation. MatrixCollect® 100 does not contain any extrinsic carriers and is entirely derived from 100% allograft bone. MatrixCollect® 100 is provided in a ready to use syringe or jar.

MatrixCollect® 100 is provided with a medical device Sterility Assurance Level (SAL) 10⁻⁶. The product should be stored in ambient temperatures and has a shelf life of up to two years from the date of packaging.

MatrixCollect® 100 is indicated for homologous use for the treatment of surgically created or traumatic skeletal defects.

We employ strict quality assurance and quality control procedures to ensure patient safety. Our medical director, a licensed physician, performs an extensive medical review of the donor's medical/social history to determine eligibility. Only donors whose screening, serologic, and microbiologic tests meet or exceed the current standards established by the Food and Drug Administration (FDA) and the American Association of Tissue Banks (AATB) are accepted for transplantation.

MatrixCollect® 100 may be used in surgical procedures:

- Spine
- Neuro
- Orthopedics
- Trauma
- Reconstruction
- Foot & Ankle
- Dental

Biologics

MatrixCelect® 100 DBM Crunch

Only Available in the US for Domestic Non-Laboratory or Research Use

MatrixCelect® 100 DBM Crunch is derived from 100% allograft bone.



Image	Item No.	Description
	455010	1.0 cc
	455025	2.5 cc
	455050	5.0 cc
	455100	10.0 cc

MatrixCelect® 100 DBM Crunch is processed using our proprietary demineralization process. It has been histologically proven post-sterilization to exhibit five elements of bone formation. MatrixCelect® 100 DBM Crunch does not contain any extrinsic carriers and is entirely derived from 100% allograft bone. MatrixCelect® 100 DBM Crunch is provided in a jar.

MatrixCelect® 100 DBM Crunch is provided with a medical device Sterility Assurance Level (SAL) 10⁻⁶. The product should be stored in ambient temperatures and has a shelf life of up to two years from the date of packaging.

MatrixCelect® 100 DBM Crunch is indicated for homologous use for the treatment of surgically created or traumatic skeletal defects.

We employ strict quality assurance and quality control procedures to ensure patient safety. Our medical director, a licensed physician, performs an extensive medical review of the donor's medical/social history to determine eligibility. Only donors whose screening, serologic, and microbiologic tests meet or exceed the current standards established by the Food and Drug Administration (FDA) and the American Association of Tissue Banks (AATB) are accepted for transplantation.

MatrixCelect® 100 DBM Crunch may be used in surgical procedures including:

- Spine
- Neuro
- Orthopedics
- Trauma

Biologics

ConCelltrate® 100

Only Available in the US for Domestic Non-Laboratory or Research Use



ConCelltrate® 100 is derived from 100% human allograft bone.

Image	Item No.	Description
	453005*	0.5 cc
	453010*	1.0 cc
	453025*	2.5 cc
	453050*	5.0 cc
	453100*	10 cc

* Available upon request, not available online.

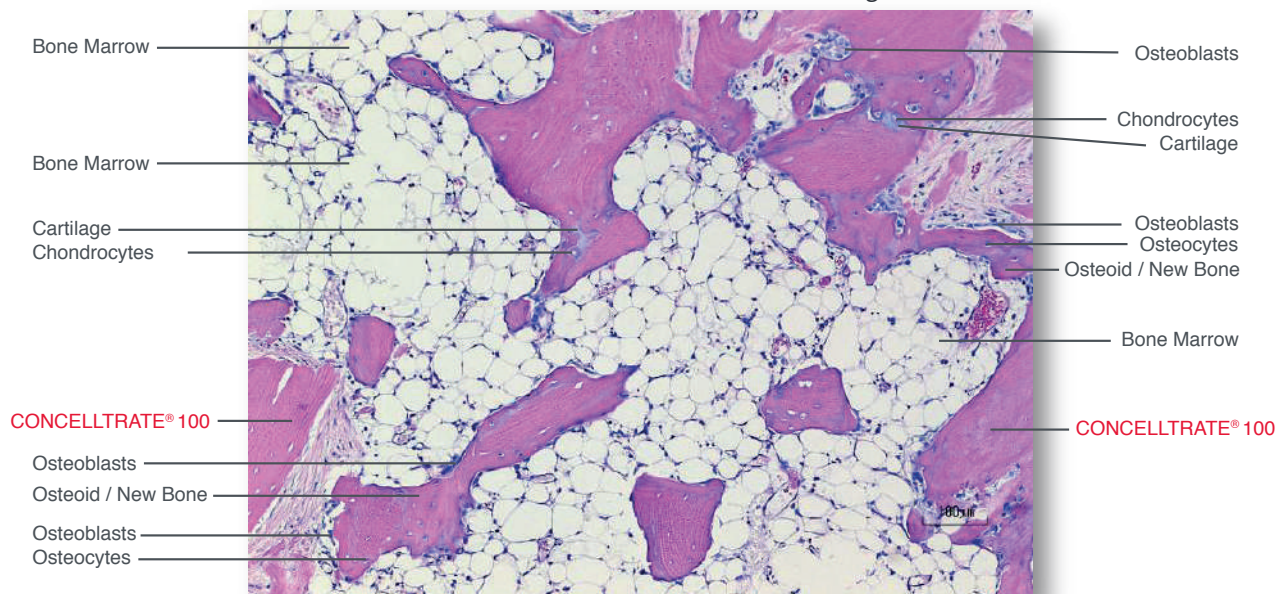

ConCelltrate® 100 Histology

ConCelltrate® 100 has been histologically proven to contain all 5 elements of bone formation including new bone, bone marrow, osteocytes, chondrocytes, and cartilage in the athymic rat post-implantation at 28 days. In-vivo testing is performed by an independent laboratory on every lot post-sterilization.

ConCelltrate® 100 is processed using our proprietary process. ConCelltrate® 100 may be hydrated with saline, blood, Bone Marrow Aspirate (BMA), Platelet Rich Plasma (PRP), or other cellular components in accordance with a physician's well-informed medical judgement. ConCelltrate® 100 does not contain any extrinsic carriers and is entirely derived from 100% human allograft bone. ConCelltrate® 100 is provided in a ready to use mixing jar.

ConCelltrate® 100 is provided sterile with a medical device Sterility Assurance Level (SAL) 10⁻⁶. The product should be stored in ambient temperatures and has a shelf-life of up to five years from the date of packaging.

We employ strict quality assurance and quality control procedures to ensure patient safety. Our medical director, a licensed physician, performs an extensive medical review of the donor's medical/social history to determine eligibility. Only donors whose screening, serologic, and microbiologic tests meet or exceed the current standards established by the Food and Drug Administration (FDA) and the American Association of Tissue Banks (AATB) are accepted for transplantation.

ConCelltrate® 100 is indicated for homologous use for the treatment of surgically created or traumatic skeletal defects.

ConCelltrate® 100 may be used in surgical procedures including:

- Spine
- Neuro
- Orthopedics
- Trauma
- Dental
- Foot & Ankle
- Reconstruction

Biologics

MatrixOI® Cortical Fibers

Only Available in the US for Domestic Non-Laboratory or Research Use

Image	Item No.	Description
	445010*	Extra Small (approx. 1.0 cc)
	445025*	Small (approx. 2.5 cc)
	445050*	Medium (approx. 5.0 cc)
	445100*	Medium (approx. 10 cc)

* Available upon request, not available online.

Matrix OI® cortical fibers have been histologically proven to contain all 5 elements of bone formation including new bone, bone marrow, osteocytes, chondrocytes, and cartilage in the athymic rat post-implantation at 28 days. In-vivo testing is performed by an independent laboratory on every Matrix OI® lot post-sterilization.

Matrix OI® cortical fibers are processed using our proprietary BioRinse® process. Matrix OI® cortical fibers may be hydrated with saline, blood, Bone Marrow Aspirate (BMA), Platelet Rich Plasma (PRP), or other cellular components in accordance with a physician's well-informed medical judgement. Matrix OI® cortical fibers do not contain any extrinsic carriers, and are derived entirely from 100% human allograft bone. Matrix OI® cortical fibers

are provided in a ready to use mixing jar.

Matrix OI® cortical fibers are provided sterile with a medical device Sterility Assurance Level (SAL) 10⁻⁶. The product should be stored in ambient temperatures and has a shelf life of five years from the date of packaging.

We employ strict quality assurance and quality control procedures to ensure patient safety. Our medical director, a licensed physician, performs an extensive medical review of the donor's medical/social history to determine eligibility. Only donors whose screening, serologic, and microbiologic tests meet or exceed the current standards established by the Food and Drug Administration (FDA) and the American Association of Tissue Banks (AATB) are

Matrix OI® cortical fibers are derived from 100% human allograft bone.

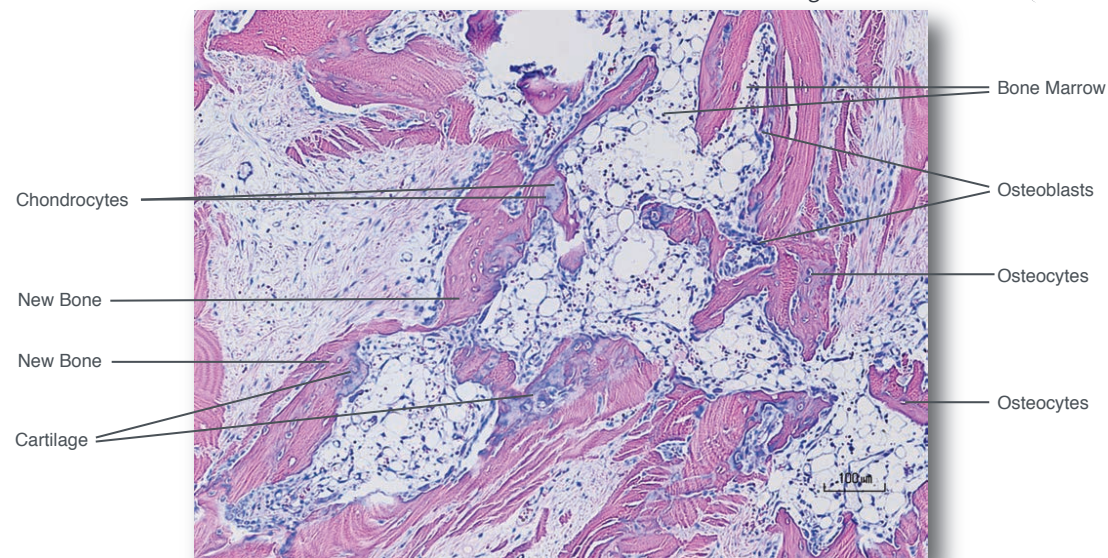

Matrix OI® Cortical Fibers Histology

accepted for transplantation.

Matrix OI® cortical fibers are indicated for homologous use for the treatment of surgically created or traumatic skeletal defects.

Matrix OI® cortical fibers may be used in surgical procedures including:

- Spine
- Neuro
- Orthopedics
- Trauma
- Reconstruction
- Foot & Ankle
- Dental

Biologics

MatrixOI® Fusion Matters

Only Available in the US for Domestic Non-Laboratory or Research Use

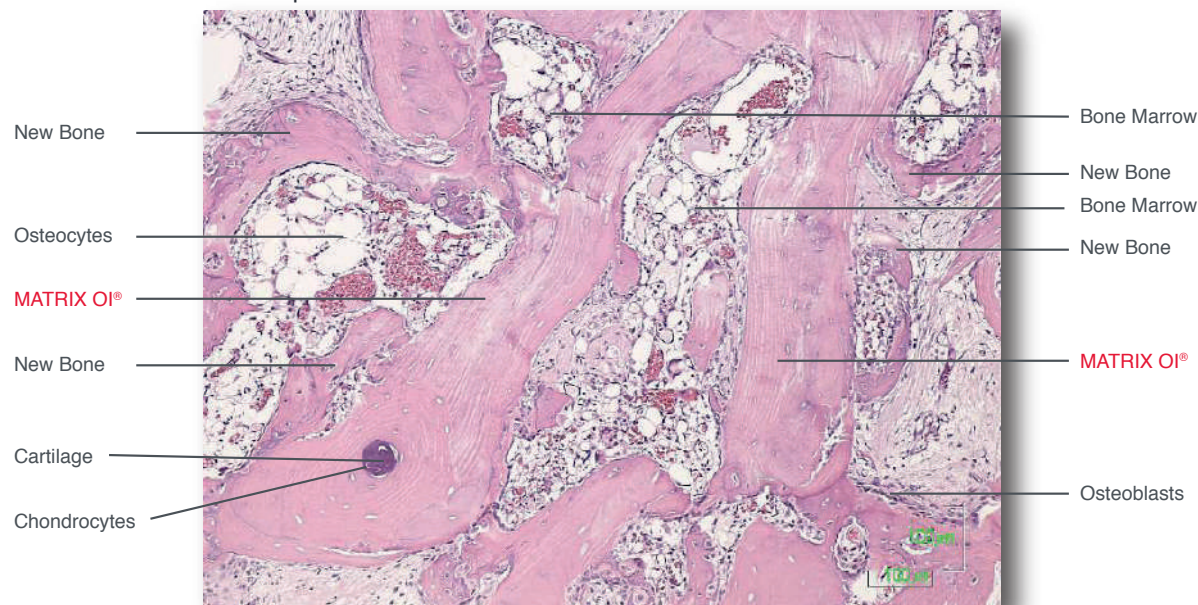

Image	Item No.	Description
	442002*	50 x 7 x 5 mm
	442003*	20 x 15 x 7 mm
	442004*	25 x 10 x 7 mm
	442006*	50 x 10 x 7 mm
	442007*	50 x 20 x 7 mm
	442008*	26 x 19 x 7 mm
	442001*	20 x 10 x 10 mm
	444025*	2.5 cc
	444050*	5.0 cc
	444100*	10 cc
	444150*	15 cc
	444225*	2.5 cc Jar
	444250*	5.0 cc Jar
	444300*	10 cc Jar
	444350*	15 cc Jar
		441010*
441012*		12 mm ³
441014*		14 mm ³

* Available upon request, not available online.

Each lot of Matrix OI® is tested for osteoinductivity post sterilization in-vivo for 28 days in an athymic rat to ensure the presence of bone morphogenic proteins. BMP's promote mesenchymal (BMA) cells to differentiate into chondrocytes and osteoblasts that lead to bone formation. Preserved native BMP's provide for an unparalleled osteoactive grafting material.

Matrix OI® is a compressible Stem Cell Containment™ matrix derived from 100% human bone.



Matrix OI® Histology

Matrix OI® is processed using next-generation proprietary processing method that maintains the interconnected structure of trabecular bone in a manner that preserves native bone morphogenic proteins. It allows the clinician to hydrate it with the patient's own stem cells, BMA, growth factors, PRP, or with an antibiotic solution.

Matrix OI® is indicated for homologous use in cervical and lumbar spine, scoliosis, lateral gutters, orthopedics, bone voids, recon, CMF, non-unions, foot and ankle, and dental procedures. When hydrated, Matrix OI® is a compressible scaffold that will contour with the defect.

Biologics

Purgo THE Graft™ Natural Bone Graft



BG-A15	0.25-1.0mm Porcine bone graft Qty. 0.15g Unit/Vol. ~ 0.36cc
BG-A25	0.25-1.0mm Porcine bone graft Qty. 0.25g Unit/Vol. ~ 0.60cc
BG-A05	0.25-1.0mm Porcine bone graft Qty. 0.50g Unit/Vol. ~ 1.20cc
BG-A10	0.25-1.0mm Porcine bone graft Qty. 1.00g Unit/Vol. ~ 2.40cc
BG-A20	0.25-1.0mm Porcine bone graft Qty. 2.00g Unit/Vol. ~ 4.80cc
BG-B05	1.00-2.00mm Porcine bone graft Qty. 0.50g Unit/Vol. ~ 1.80cc
BG-B10	1.00-2.00mm Porcine bone graft Qty. 1.00g Unit/Vol. ~ 3.60cc

TG-AS25	0.25-1.0mm Porcine bone graft Qty. ~ 0.25cc
TG-AS05	0.25-1.0mm Porcine bone graft Qty. ~ 0.50cc
TG-AS10	0.25-1.0mm Porcine bone graft Qty. ~ 1.00cc
TG-BS25	1.00-2.00mm Porcine bone graft Qty. ~ 0.25cc
TG-BS05	1.00-2.00mm Porcine bone graft Qty. ~ 0.50cc
TG-BS10	1.00-2.00mm Porcine bone graft Qty. ~ 1.00cc

TCB-01	7 x 7 x 7mm ~ 0.34cc
TCB-02	8 x 9 x 10mm ~ 0.72cc
TCB-03	10 x 11 x 12mm ~ 1.32cc

THE Graft™ is a natural, porous bone mineral matrix. It is produced by removal of all organic components from porcine bone. Due to its natural structure the anorganic bone mineral of THE Graft™ likens physical and chemical aspects of mineralized matrix of human bone. When packed into a bone defect, THE Graft™ gradually resorbs and is replaced with bone during the healing process. It is available in cancellous granules packaged in vial. THE Graft™ is sterilized using gamma irradiation.

THE Graft™ quality and safety have been scientifically demonstrated with in-vitro, in-vivo studies, large case study reports and international randomized clinical research. Systematic review and meta-analysis are conducted on THE Graft™ worldwide. THE Graft™ has established its fame throughout the world, both scientifically and clinically, becoming the favourite bone regeneration material.

THE Graft™ Collagen, a form of block and ring composed of the porcine-derived bone mineral matrix from cancellous bone and atelocollagen from porcine tendon, is a material used to fill, augment, and/or reconstruct periodontal, oral, and maxillofacial defects. The bone mineral matrix is similar to the physical and chemical aspects of the mineralized matrix of human bone. Hydrated collagen components have a viscosity that facilitates for the blending of a bone mineral matrix.

Sutures

MONOGLYC

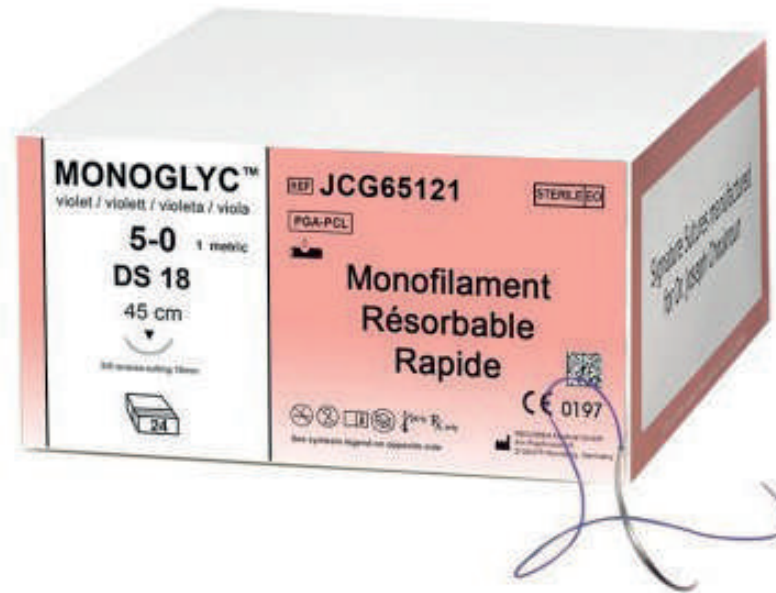

Image	Item No.	Size	Needle	Thread length	Thread color	Resorption	Quantity
	JCG61507	5/0	DSM 13 Premium (3/8)	70 cm	Violet	Fast	Box of 24 threads
	JCG65109	5/0	DSM 16 Premium (3/8)	45 cm	Violet	Fast	Box of 24 threads
	JCG65116	4/0	DS 18 (needle 3/8 18 mm)	70 cm	Violet	Fast	Box of 24 threads
	JCG65120	4/0	DS 18 (needle 3/8 18 mm)	45 cm	Violet	Fast	Box of 24 threads
	JCG65121	5/0	DS 18 (needle 3/8 18 mm)	45 cm	Violet	short term	Box of 24 threads
	JCG65122	5/0	DS 18 (needle 3/8 18 mm)	70 cm	Violet	short term	Box of 24 threads
	JCG65127	6/0	DSM 13 Premium (3/8)	45 cm	Violet	Fast	Box of 24 threads
	JCG61417	4/0	DS 21 (needle 3/8 21 mm)	70 cm	Violet	Fast	Box of 24 threads

PRF

DUO Quattro Centrifuge



The PRF centrifuge **DUO Quattro** has a «push» button that affords you to select between 6 different PRF protocols. The values of these settings are preset but not locked.



Simply push the button to select the desired mode of operation, the corresponding LED will light on. The machine is ready. Simply press the button to start the centrifugation.

PRF STARTER System

- 1 PRF DUO Quattro
- 100 A- tubesPRF
- 24 tubes S-PRF
- 24 samplers
- 1 PRF BoX
- 2 PomPac™
- 1 PomCol™
- 1 PomSwing pack
- 1 Polysteribox
- 1 Silicone mat
- 1 PRF Forceps
- 1 PRF GIRAFE forceps

- 1 PRF Scissors
- 1 PRF Pad
- 1 Cupule
- 1 Tray
- 1 Tube holder
- 1 Tourniquet
- 1 Compactor Big
- 1 Compactor Small
- 1 Mini tray
- 30 Bandages

Supplied with 100 safety pins and 50 sterilization labels

PRF PROFESSIONAL System

- 1 PRF DUO Quattro
- 100 A- tubesPRF
- 24 tubes S-PRF
- 24 samplers
- 2 PRF BoX
- 2 PomPac™
- 1 PomCol™
- 2 PomSwing pack
- 2 Polysteribox
- 2 Silicone mat
- 2 PRF Tweezers
- 2 PRF GIRAFE forceps

- 2 PRF Scissors
- 2 PRF Pad
- 2 Cups
- 2 Tray
- 2 Tube holder
- 2 Tourniquet
- 2 Compactor Big
- 2 Compactor Small
- 2 Mini tray
- 60 Bandages

Supplied with 100 safety pins and 50 sterilization labels

In the event of an injury, the human body helps itself by producing proteins that accelerate wound healing. This process is used in the production of natural tissue - these proteins and growth factors are isolated from the patient's own blood by centrifugation and then used to accelerate healing.

The treatment is completely natural and only 100% autologous material is used. This means that the tissue to be regenerated can be healed or even replaced without having to use additives such as anticoagulants.

Natural regeneration in a completely new form. The matrix obtained using the PRF (Platelet Rich Fibrin) method contains proteins and a particularly large number of white blood cells, in which important information on tissue structure is stored - a decisive advantage in the healing process of the tissue to be regenerated.

Tools

Surgical Instruments from Ustomed and Laschal
Handpieces from mk-dent



Surgery

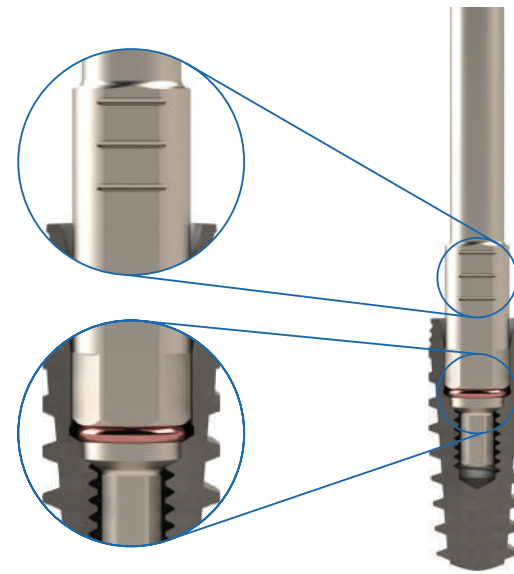
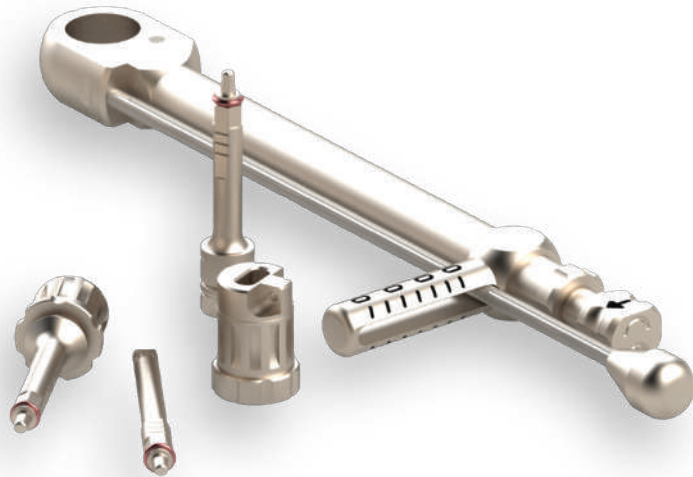

Many insertion tools/motor mounts are provided with a fixing mechanism to prevent loss of the temporary attachment and gingiva height markings in mm increments – for better orientation of the insertion depths.

Compact Surgical Kit

Art. No. RIBUS-SE



Reason #23, 24, 25

This Compact Surgical Kit contains all basic tools and drills to place all Ritter SB/LA Implants and system components. **The drill stop function is provided by stopper sleeves.**

#23

This is our Compact Kit and this kit is very similar to most Surgical kits on the Market. It comes with Limited amounts of Drills, one for each Implant Diameter (part # DEP). But unlike most – **this kit comes with the tools to place both Ritter Platforms.**

#24

In addition it contains Manually applied Drill Stoppers – most companies do not include (part #'s DS-6-13)

All placing tools are included – Motor Mount (MMIB) are for the Handpiece and Ratchet Driver (RDI) are for the included torque Ratchet (TRU-70BG)

The Kit also has prosthetic drivers for both the ratchet and the Handpiece – most companies force you to purchase an additional kit.

#25

Important note:
Please use only these tools to pick the implant from the tube!

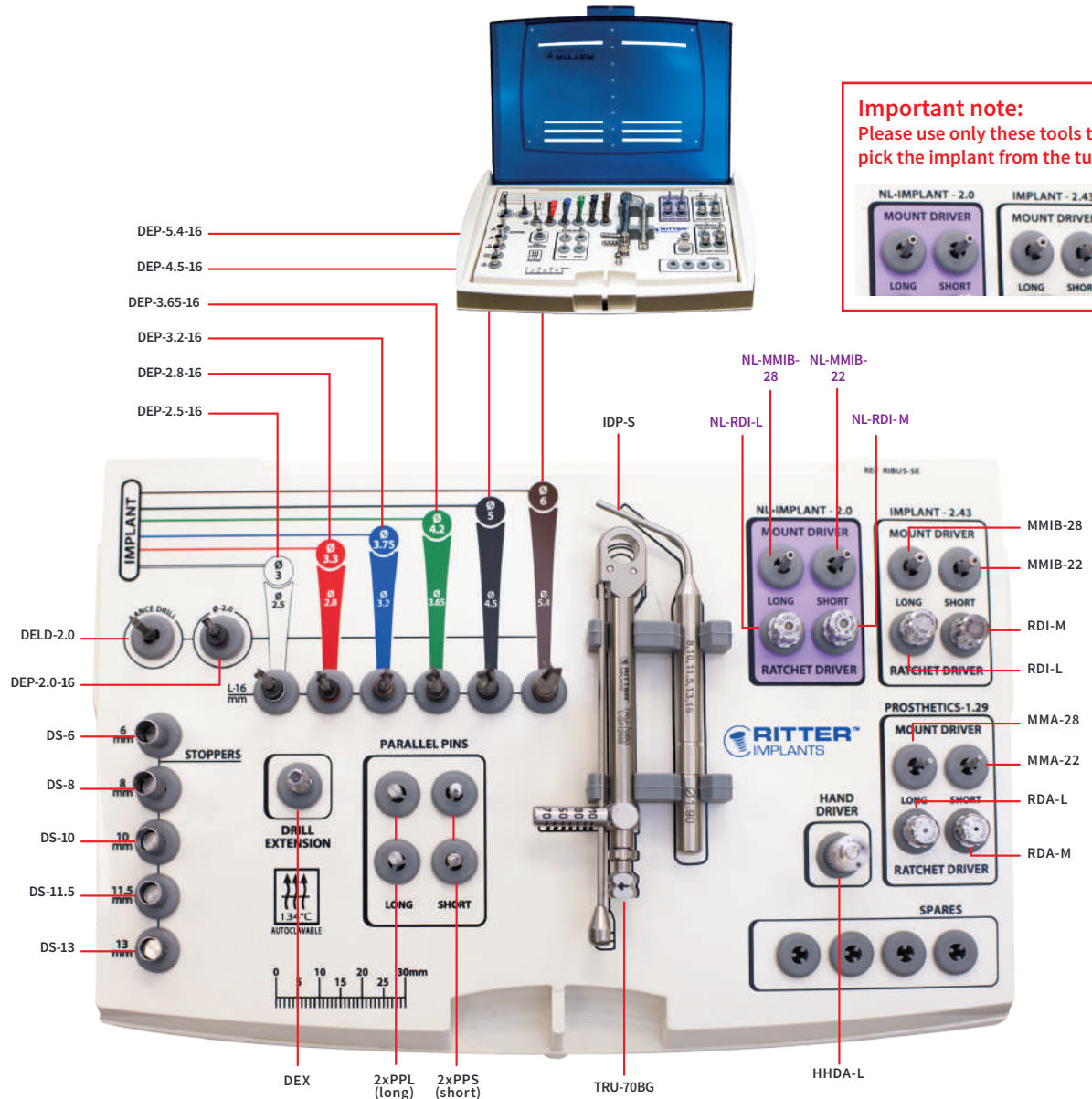

Ritter Surgical Kits & Tools

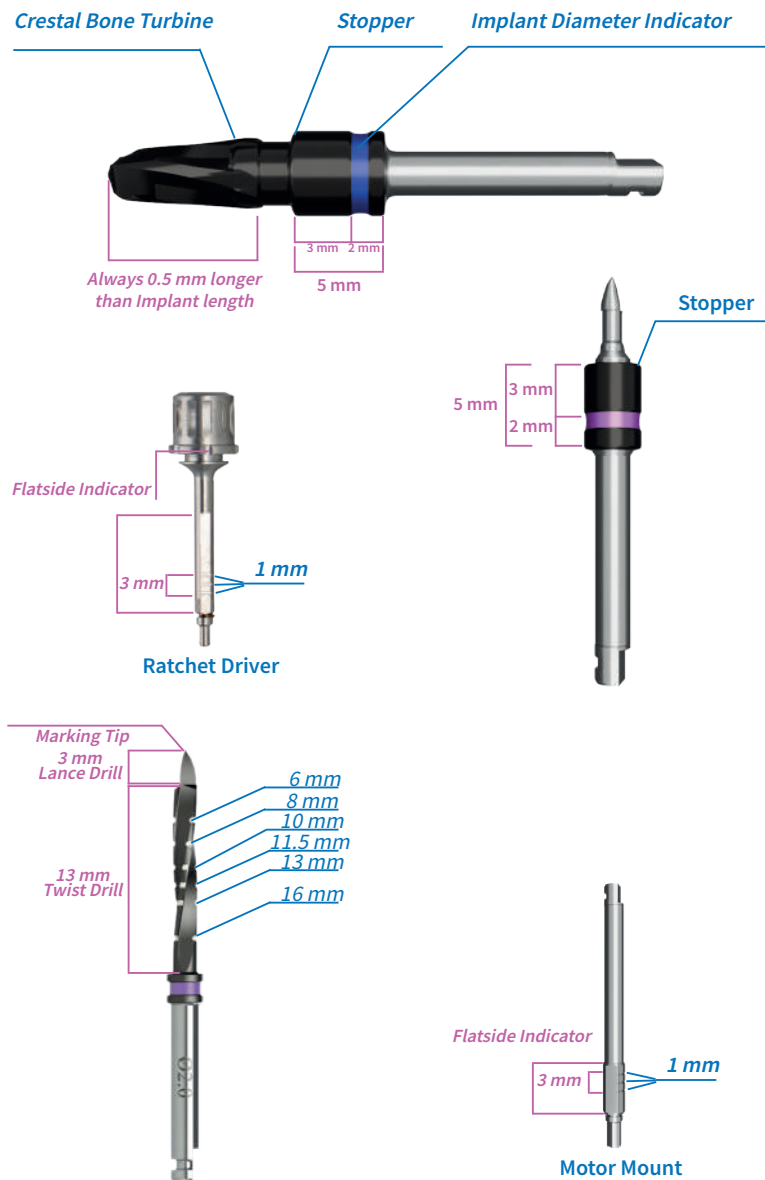

Complete Surgical Kit
 Art.-No. RIBEU-PE

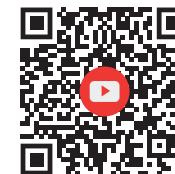

Complete Surgical Kit

Art. No. RIBEU-PE (Rev. 7.0)



Reason #26, 27, 28, 29

Our Complete surgical kit is second to no one. It contains all the items of the Compact Kit – except the **Stoppers are built into each drill** – there is a drill for every Implant we produce and more!

#26

This comes with our exclusive 3 in one – Starter/Marking/Lance Drill.

#27

Along with all the special measuring and registration markings on all tools.

#28

All Implant drivers are spring loaded – making it Impossible for an Implant to fall down a persons throat!

#29

Conical Drills- External Irrigation

- CDEP-6.0-6
- CDEP-6.0-8
- CDEP-6.0-10
- CDEP-6.0-11.5
- CDEP-6.0-13

- CDEP-5.0-6
- CDEP-5.0-8
- CDEP-5.0-10
- CDEP-5.0-11.5
- CDEP-5.0-13
- CDEP-5.0-16

- CDEP-4.2-6
- CDEP-4.2-8
- CDEP-4.2-10
- CDEP-4.2-11.5
- CDEP-4.2-13
- CDEP-4.2-16

- CDEP-3.75-6
- CDEP-3.75-8
- CDEP-3.75-10
- CDEP-3.75-11.5
- CDEP-3.75-13
- CDEP-3.75-16

- CDEP-3.3-6
- CDEP-3.3-8
- CDEP-3.3-10
- CDEP-3.3-11.5
- CDEP-3.3-13
- CDEP-3.3-16

- CDEP-3.0-6
- CDEP-3.0-8
- CDEP-3.0-10
- CDEP-3.0-11.5
- CDEP-3.0-13
- CDEP-3.0-16

- Motor Mount for Implant Self Loading 2.0 Hex NL-MMIB-28
- NL-MMIB-22

- Ratchet-Driver for Implant 2.0 Hex NL-RDI-L (long)
- NL-RDI-M (short)

- Motor Mount for Implant Self Loading 2.43 Hex MMIB-28
- MMIB-22

- Ratchet Driver for Implant 2.43 Hex RDI-L (long)
- RDI-M (short)

- Direction Indicator Pin DPU

- Drill Extender for external irrigation Drills DEX

- Torque Ratchet 70 Ncm with Measuring Arm TRU-70BG

Hard Bone Drills for Implants (ø mm)

- CD-3.0
- CD-3.3
- CD-3.75
- CD-4.2
- CD-5.0
- CD-6.0

- Hand Hex Driver for prosthetics 1.29 Hex HHDA-L (long)
- HHDA-S (short)

- Motor Mount for Prosthetics 1.29 Hex MMA-28

- Ratchet Driver for Prosthetics 1.29 Hex RDA-L (long)
- RDA-M (short)

Lance Drills ø 2 mm

- DELD-2.0-6
- DELD-2.0-8
- DELD-2.0-10
- DELD-2.0-11.5

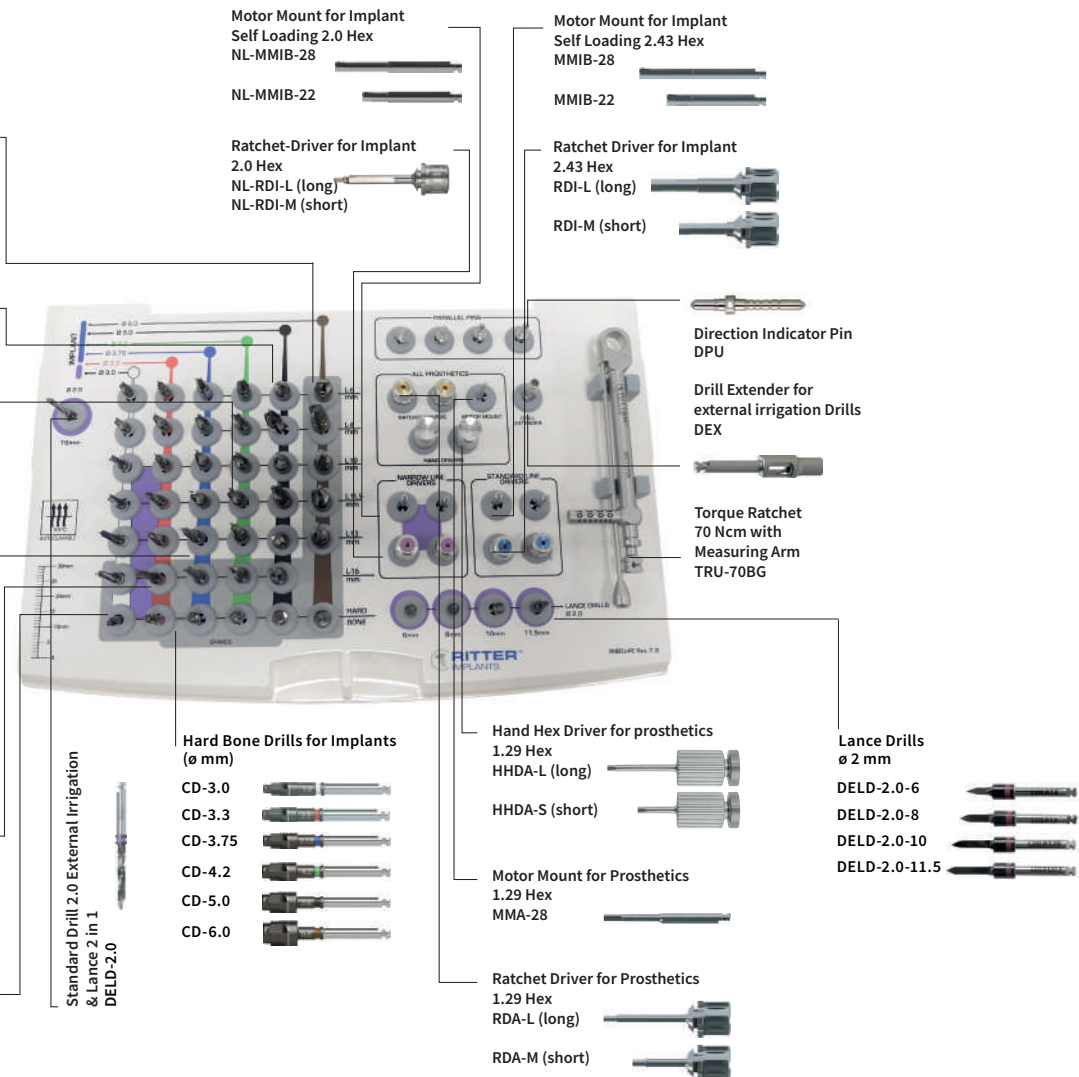

Ritter Surgical Kits & Tools

STANDARD LINE

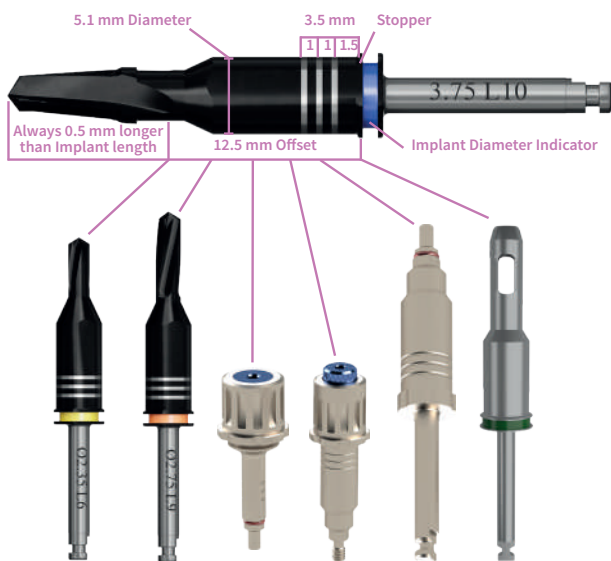

NARROW LINE



UNIVERSAL



This guided system contains all the tools and drills necessary to perform a guided operation with all diameters except 6 mm, including narrow line. Class IIa (CE1023) Category



Guided Surgical Kit

Art.-No. GSKIT (Rev. 2.2)



Reason #30, 31, 32, 33

The Guided Kit is one of the Best and Easiest on the Market. Most guided kits do not have a drill for every length and Diameter – Ritter Does!

#30

Most Guided kits need to use spoons to change drill diameter - Ritter is spoonless! #31

Most Guided kits need metal sleeves in the guide because they guide the cutting portion of the Drill – Ritter guides the barrel of the drill and is sleeveless! #32

The Torque Ratchet has a simple screw to reverse the direction of turning. #33

Guided Drills - External Irrigation

- GSD-5.0-6
- GSD-5.0-8
- GSD-5.0-10
- GSD-5.0-11.5
- GSD-5.0-13
- GSD-5.0-16
- GSD-4.2-6
- GSD-4.2-8
- GSD-4.2-10
- GSD-4.2-11.5
- GSD-4.2-13
- GSD-4.2-16
- GSD-3.75-6
- GSD-3.75-8
- GSD-3.75-10
- GSD-3.75-11.5
- GSD-3.75-13
- GSD-3.75-16
- NL-GSD-3.3-10
- NL-GSD-3.3-11.5
- NL-GSD-3.3-13
- NL-GSD-3.3-16
- NL-GSD-3.0-10
- NL-GSD-3.0-11.5
- NL-GSD-3.0-13
- NL-GSD-3.0-16

- NL-GSSDL-2.35-6
- GSSDL-2.35-6
- GSSDL-2.75-9

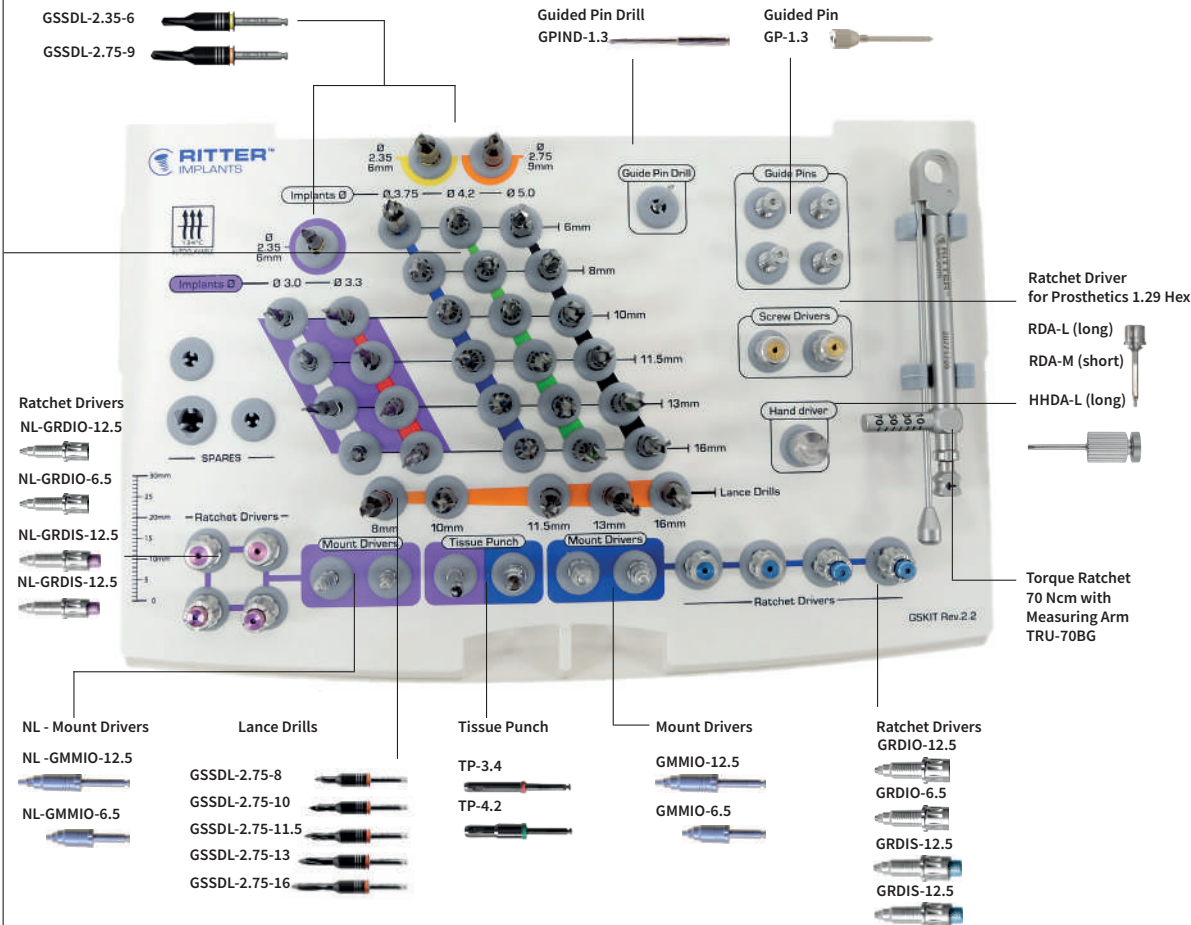

Laboratory/Prosthetics Kit complete



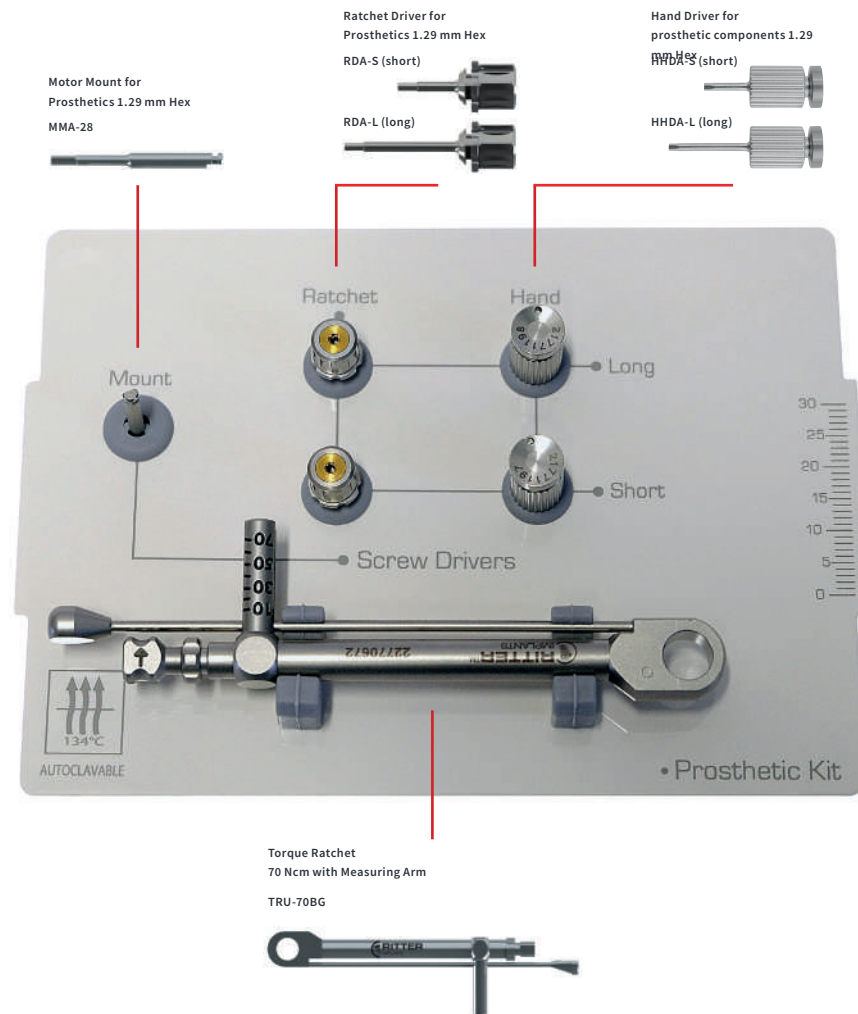

Art. No. RIB-PROS

The Laboratory Kit with all the necessary tools for prosthetics components.

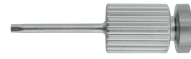
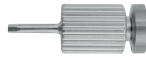

Art. No. RI-PROS

RIB-PROS Prosthetics Kit - components, individually reorderable

	Art. No.	Description
	HHDA-L	Hand Hex Driver for Prosthetics, Hex 1.29 mm, long
	HHDA-S	Hand Hex Driver for Prosthetics, Hex 1.29 mm, short
	MMA-28	Motor Mount 28 mm L for Prosthetics, (for Hex 1.29 mm)
	RDA-S	Ratchet Driver for Prosthetics, short for Hex 1.29 mm
	RDA-L	Ratchet Driver for Prosthetics, long for Hex 1.29 mm
	TRU-70BG	70 Ncm Torque Ratchet with Measuring Arm

RIBUS-SE Compact Surgical Kit – components, individually reorderable



































	Art. No.	Description
	DEP-2.0-16	Standard Drill 2.0 mm D 16 mm L External Irrigation
	DEP-2.5-16	Standard Drill 2.5 mm D 16 mm L External Irrigation
	DEP-2.8-16	Standard Drill 2.8 mm D 16 mm L External Irrigation
	DEP-3.2-16	Standard Drill 3.2 mm D 16 mm L External Irrigation
	DEP-3.65-16	Standard Drill 3.65 mm D 16 mm L External Irrigation
	DEP-4.5-16	Standard Drill 4.5 mm D 16 mm L External Irrigation
	DEP-5.4-16	Standard Drill 5.4 mm D 16 mm L External Irrigation
	DELD-2.0	Multi Purpose 2.0 Lance Starter Marking Drill
	DS-6	Drill Stopper 6 mm (Universal)
	DS-8	Drill Stopper 8 mm (Universal)
	DS-10	Drill Stopper 10 mm (Universal)
	DS-11.5	Drill Stopper 11.5 mm (Universal)
	DS-13	Drill Stopper 13 mm (Universal)
	DEX	Drill Extension for External Irrigation Drill
	PPL	Parallel Pin Guide - 16 mm (long)
	PPS	Parallel Pin Guide - 10 mm (short)
	HHDA-L	Hand Hex Driver for Prosthetics, Hex 1.25, long
	MMA-22	Motor Mount 22 mm L for Prosthetics, (for Hex 1.29)
	MMA-28	Motor Mount 28 mm L for Prosthetics, (for Hex 1.29)
	IDP-S	Implant Depth Probe - single end
	TRU-70BG	70 Ncm Torque Ratchet with Measuring Arm
	MMIB-22	Motor Mount 22 mm L for Implant (for Hex 2.43)
	MMIB-28	Motor Mount 28 mm L for Implant (for Hex 2.43)





































	Art. No.	Description
	RDA-M	Ratchet Driver for Prosthetics, medium for Hex 1.29 mm
	RDA-L	Ratchet Driver for Prosthetics, long for Hex 1.29 mm
	RDI-M	Ratchet Driver for Implant, medium for Hex 2.43 mm
	RDI-L	Ratchet Driver for Implant, long for Hex 2.43 mm
	NL-MMIB-22	Motor Mount 22 mm L for Implant (for Hex 2.0 Narrow Line)
	NL-MMIB-28	Motor Mount 28 mm L for Implant (for Hex 2.0 Narrow Line)
	NL-RDI-M	Ratchet Driver for Implant, medium (for Hex 2.0 Narrow Line)
	NL-RDI-L	Ratchet Driver for Implant, long (for Hex 2.0 Narrow Line)

RIBEU-PE Complete Surgical Kit – components, individually reorderable

	Art. No.	Description
	CDEP-3.0-6	Conical Drill 2.5 mm D 6 mm L External Irrigation
	CDEP-3.0-8	Conical Drill 2.5 mm D 8 mm L External Irrigation
	CDEP-3.0-10	Conical Drill 2.5 mm D 10 mm L External Irrigation
	CDEP-3.0-11.5	Conical Drill 2.5 mm D 11.5 mm L External Irrigation
	CDEP-3.0-13	Conical Drill 2.5 mm D 13 mm L External Irrigation
	CDEP-3.0-16	Conical Drill 2.5 mm D 16 mm L External Irrigation
	CDEP-3.3-6	Conical Drill 2.8 mm D 6 mm L External Irrigation
	CDEP-3.3-8	Conical Drill 2.8 mm D 8 mm L External Irrigation
	CDEP-3.3-10	Conical Drill 2.8 mm D 10 mm L External Irrigation
	CDEP-3.3-11.5	Conical Drill 2.8 mm D 11.5 mm L External Irrigation
	CDEP-3.3-13	Conical Drill 2.8 mm D 13 mm L External Irrigation
	CDEP-3.3-16	Conical Drill 2.8 mm D 16 mm L External Irrigation
	CDEP-3.75-6	Conical Drill 3.2 mm D 6 mm L External Irrigation
	CDEP-3.75-8	Conical Drill 3.2 mm D 8 mm L External Irrigation
	CDEP-3.75-10	Conical Drill 3.2 mm D 10 mm L External Irrigation
	CDEP-3.75-11.5	Conical Drill 3.2 mm D 11.5 mm L External Irrigation
	CDEP-3.75-13	Conical Drill 3.2 mm D 13 mm L External Irrigation
	CDEP-3.75-16	Conical Drill 3.2 mm D 16 mm L External Irrigation
	CDEP-4.2-6	Conical Drill 3.65 mm D 6 mm L External Irrigation
	CDEP-4.2-8	Conical Drill 3.65 mm D 8 mm L External Irrigation
	CDEP-4.2-10	Conical Drill 3.65 mm D 10 mm L External Irrigation
	CDEP-4.2-11.5	Conical Drill 3.65 mm D 11.5 mm L External Irrigation
	CDEP-4.2-13	Conical Drill 3.65 mm D 13 mm L External Irrigation
	CDEP-4.2-16	Conical Drill 3.65 mm D 16 mm L External Irrigation
	CDEP-5.0-6	Conical Drill 4.5 mm D 6 mm L External Irrigation
	CDEP-5.0-8	Conical Drill 4.5 mm D 8 mm L External Irrigation
	CDEP-5.0-10	Conical Drill 4.5 mm D 10 mm L External Irrigation
	CDEP-5.0-11.5	Conical Drill 4.5 mm D 11.5 mm L External Irrigation
	CDEP-5.0-13	Conical Drill 4.5 mm D 13 mm L External Irrigation
	CDEP-5.0-16	Conical Drill 4.5 mm D 16 mm L External Irrigation
	CDEP-6.0-6	Conical Drill 5.4 mm D 6 mm L External Irrigation
	CDEP-6.0-8	Conical Drill 5.4 mm D 8 mm L External Irrigation
	CDEP-6.0-10	Conical Drill 5.4 mm D 10 mm L External Irrigation
	CDEP-6.0-11.5	Conical Drill 5.4 mm D 11.5 mm L External Irrigation
	CDEP-6.0-13	Conical Drill 5.4 mm D 13 mm L External Irrigation



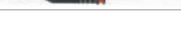





	Art. No.	Description
	CD-3.0	Hardbone Drill
	CD-3.3	Hardbone Drill
	CD-3.75	Hardbone Drill
	CD-4.2	Hardbone Drill
	CD-5.0	Hardbone Drill
	CD-6.0	Hardbone Drill
	DELD-2.0	Multi Purpose 2.0 Lance Starter Marking Drill
	DELD-2.0-6	Lance Drill 2.0 mm D 6 mm L (from Rev. 7.0)
	DELD-2.0-8	Lance Drill 2.0 mm D 8 mm L (from Rev. 7.0)
	DELD-2.0-10	Lance Drill 2.0 mm D 10 mm L (from Rev. 7.0)
	DELD-2.0-11.5	Lance Drill 2.0 mm D 11.5 mm L (from Rev. 7.0)
	DEX	Drill Extension for External Irrigation Drill
	DPU	Direction Indicator Pin
	TRU-70BG	70 Ncm Torque Ratchet with Measuring Arm
	HHDA-L	Hand Hex Driver for Prosthetics, Hex 1.25, long
	HHDA-S	Hand Hex Driver for Prosthetics, Hex 1.25, short
	MMA-28	Motor Mount 28 mm L for Prosthetics, (for Hex 1.29)
	RDA-M	Ratchet Driver for Prosthetics, medium for Hex 1.29 mm
	RDA-L	Ratchet Driver for Prosthetics, long for Hex 1.29 mm
	MMIB-22	Motor Mount 22 mm L for Implant (for Hex 2.43)
	MMIB-28	Motor Mount 28 mm L for Implant (for Hex 2.43)
	RDI-M	Ratchet Driver for Implant, medium for Hex 2.43 mm
	RDI-L	Ratchet Driver for Implant, long for Hex 2.43 mm
	NL-MMIB-22	Motor Mount 22 mm L for Implant (for Hex 2.0 Narrow Line)
	NL-MMIB-28	Motor Mount 28 mm L for Implant (for Hex 2.0 Narrow Line)
	NL-RDI-M	Ratchet Driver for Implant, medium (for Hex 2.0 Narrow Line)
	NL-RDI-L	Ratchet Driver for Implant, long (for Hex 2.0 Narrow Line)

GSKIT Navigated Surgical Kit – components, individually reorderable

	Art. No.	Description
	GSD-3.75-6	Guided Surgery Drill 3.75 mm D 6 mm L
	GSD-3.75-8	Guided Surgery Drill 3.75 mm D 8 mm L
	GSD-3.75-10	Guided Surgery Drill 3.75 mm D 10 mm L
	GSD-3.75-11.5	Guided Surgery Drill 3.75 mm D 11.5 mm L
	GSD-3.75-13	Guided Surgery Drill 3.75 mm D 13 mm L
	GSD-3.75-16	Guided Surgery Drill 3.75 mm D 16 mm L
	GSD-4.2-6	Guided Surgery Drill 4.2 mm D 6 mm L
	GSD-4.2-8	Guided Surgery Drill 4.2 mm D 8 mm L
	GSD-4.2-10	Guided Surgery Drill 4.2 mm D 10 mm L
	GSD-4.2-11.5	Guided Surgery Drill 4.2 mm D 11.5 mm L
	GSD-4.2-13	Guided Surgery Drill 4.2 mm D 13 mm L
	GSD-4.2-16	Guided Surgery Drill 4.2 mm D 16 mm L
	GSD-5.0-6	Guided Surgery Drill 5.0 mm D 6 mm L
	GSD-5.0-8	Guided Surgery Drill 5.0 mm D 8 mm L
	GSD-5.0-10	Guided Surgery Drill 5.0 mm D 10 mm L
	GSD-5.0-11.5	Guided Surgery Drill 5.0 mm D 11.5 mm L
	GSD-5.0-13	Guided Surgery Drill 5.0 mm D 13 mm L
	GSD-5.0-16	Guided Surgery Drill 5.0 mm D 16 mm L
	NL-GSD-3.0-10	Narrow Line, Guided Surgery Drill 3.0 mm D 10 mm L
	NL-GSD-3.0-11.5	Narrow Line, Guided Surgery Drill 3.0 mm D 11.5 mm L
	NL-GSD-3.0-13	Narrow Line, Guided Surgery Drill 3.0 mm D 13 mm L
	NL-GSD-3.0-16	Narrow Line, Guided Surgery Drill 3.0 mm D 16 mm L
	NL-GSD-3.3-10	Narrow Line, Guided Surgery Drill 3.3 mm D 10 mm L
	NL-GSD-3.3-11.5	Narrow Line, Guided Surgery Drill 3.3 mm D 11.5 mm L
	NL-GSD-3.3-13	Narrow Line, Guided Surgery Drill 3.3 mm D 13 mm L
	NL-GSD-3.3-16	Narrow Line, Guided Surgery Drill 3.3 mm D 16 mm L
	NL-GSSDL-2.35-6	Narrow Line, Guided Surgery Lance Starter Drill 2.35 mm D 6 mm L
	GSSDL-2.35-6	Guided Surgery Lance Starter Drill 2.35 mm D 6 mm L
	GSSDL-2.75-9	Guided Surgery Lance Starter Drill 2.75 mm D 9 mm L
	CD-3.0	Hardbone Drill (only GSKIT Rev. 1.0)
	CD-3.3	Hardbone Drill (only GSKIT Rev. 1.0)
	CD-3.75	Hardbone Drill (only GSKIT Rev. 1.0)
	CD-4.2	Hardbone Drill (only GSKIT Rev. 1.0)
	CD-5.0	Hardbone Drill (only GSKIT Rev. 1.0)
	GSSDL-2.75-8	Lance Drill 2.75 D 8 mm L (from GSKIT Rev. 2.2)
	GSSDL-2.75-10	Lance Drill 2.75 D 10 mm L (from GSKIT Rev. 2.2)
	GSSDL-2.75-11.5	Lance Drill 2.75 D 11.5 mm L (from GSKIT Rev. 2.2)
	GSSDL-2.75-13	Lance Drill 2.75 D 13 mm L (from GSKIT Rev. 2.2)
	GSSDL-2.75-16	Lance Drill 2.75 D 16 mm L (from GSKIT Rev. 2.2)

	Art. No.	Description
	GMMIO-6.5	Guided Motor Mount Self-Loading Barrel 5.1 mm D 6.5 mm L
	GMMIO-12.5	Guided Motor Mount Self-Loading Barrel 5.1 mm D 12.5 mm L
	NL-GMMIO-6.5	Narrow Line Guided Motor Mount Self-Loading Barrel 3.4 mm D 6.5 mm L
	NL-GMMIO-12.5	Narrow Line Guided Motor Mount Self-Loading Barrel 3.4 mm D 12.5 mm L
	GRDIO-6.5	Guided Ratchet Driver Self-Loading Barrel 5.1 mm D 6.5 mm L
	GRDIO-12.5	Guided Ratchet Driver Self-Loading Barrel 5.1 mm D 12.5 mm L
	GRDIS-12.5	Guided Ratchet Driver Screw Receiving Barrel 5.1 mm D 12.5 mm L
	NL-GRDIO-6.5	Narrow Line Guided Ratchet Driver Self-Loading Barrel 3.4 mm D 6.5 mm L
	NL-GRDIO-12.5	Narrow Line Guided Ratchet Driver Self-Loading Barrel 3.4 mm D 12.5 mm L
	NL-GRDIS-12.5	Narrow Line Guided Ratchet Driver Screw Receiving Barrel 3.4 mm D 12.5 mm L
	GPIND-1.3	Guided Pin Drill
	GP-1.3	Guided Pin
	HHDA-L	Hand Hex Driver for Prosthetics, Hex 1.25, long
	RDA-M	Ratchet Driver for Prosthetics, medium for Hex 1.29 mm
	RDA-L	Ratchet Driver for Prosthetics, long for Hex 1.29 mm
	TRU-70BG	70 Ncm Torque Ratchet with Measuring Arm
	TP-3.4	Narrow Line Tissue Punch 3.4 mm D
	TP-4.2	Tissue Punch 4.2 mm D

Miscellaneous components

	DP-3.0	Direction Pins for 3.0 mm D Implant
	DP-3.3	Direction Pins for 3.3 mm D Implant
	DP-3.75	Direction Pins for 3.75 mm D Implant
	DP-4.2	Direction Pins for 4.2 mm D Implant
	DP-5.0	Direction Pins for 5.0 mm D Implant
	DP-6.0	Direction Pins for 6.0 mm D Implant
	MM-ADP-7	Motor Mount Adapter with Ballfriction 7 mm
	LD-2.0	Lance Drill 2.0 - 16 mm L

Drilling Protocols



**For placement of all Implant diameters
always use of Marking/Lance Drill DELD-2.0
is highly recommended**

Drilling Sequence

Standard Platform

Implant Diameter	3.75 mm	4.2 mm	5.0 mm	6.0 mm
Color Code	blue	green	black	brown
Previous of the regular drills with CDEP	1	2	3	4
Conical drill width CDEP	3.2 mm	3.2-3.65 mm	3.2-4.5 mm	3.2-5.4 mm
Final regular drill with max. depth / according to the length of the implant	3.2 mm	3.65 mm	4.5 mm	5.4 mm

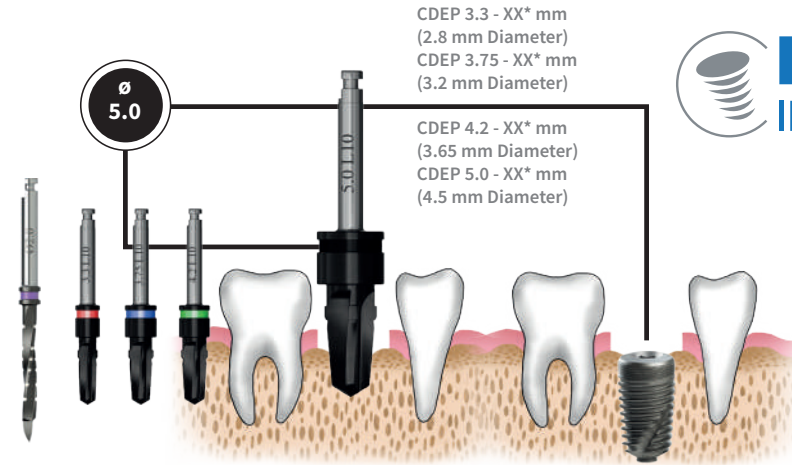

**For placement of all Implant diameters
always use of Marking/Lance Drill DELD-2.0
is highly recommended**

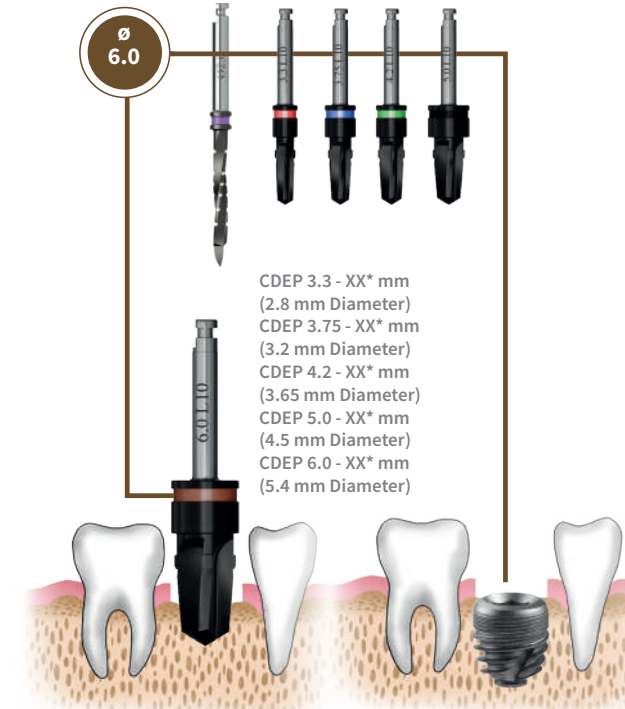
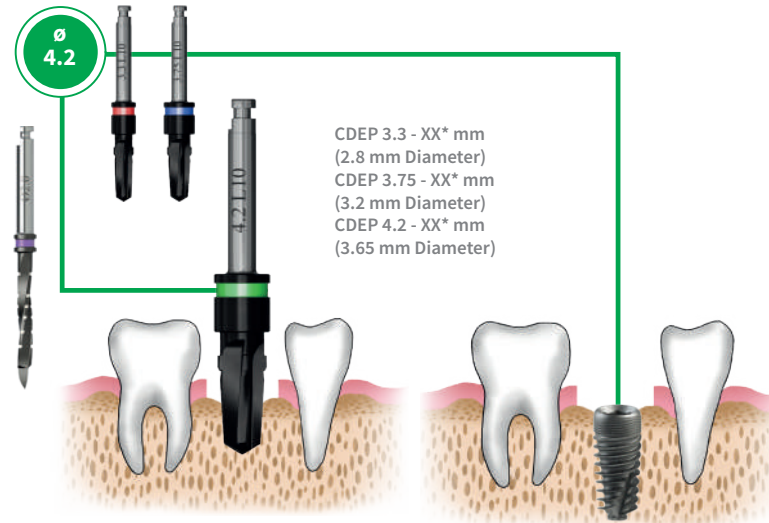
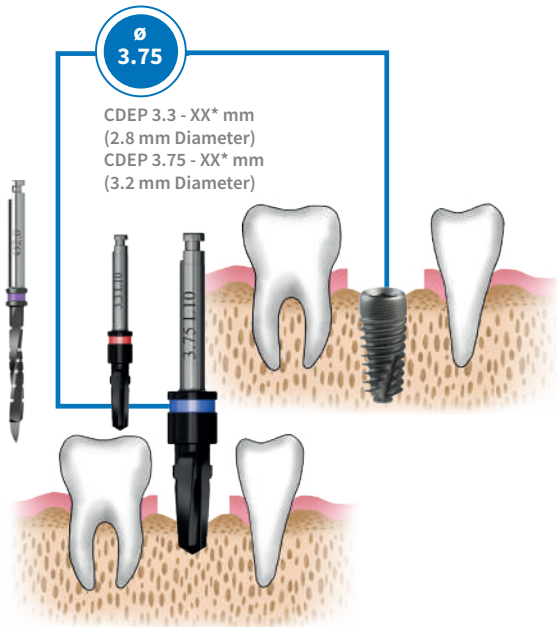

Drilling Protocols

Narrow Line 3.0 and 3.3 mm Platform

Implant Diameter	3.0 mm	3.3 mm
Color Code	white	red
Previous of the regular drills with CDEP	-- only Pilot-Drill LD 2.0	1
Conical Drill width CDEP	--	2.8 mm
Final regular drill with max. depth / according to the length of the implant	2.5 mm	2.8 mm



For placement of all Implant diameters always use of Marking/Lance Drill DELD-2.0 is highly recommended

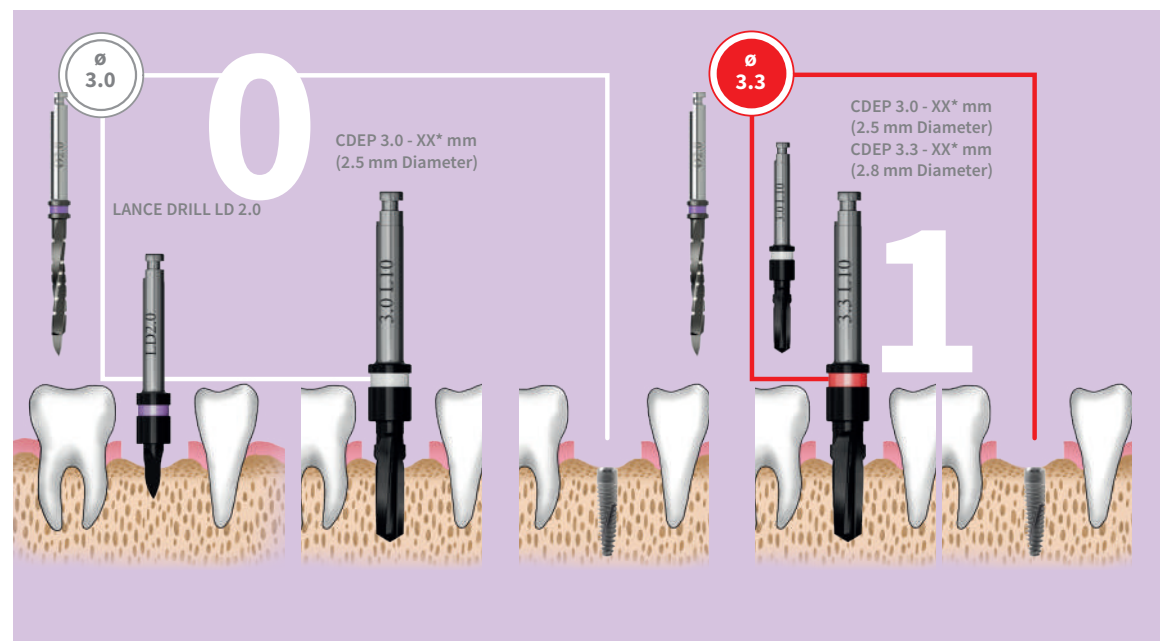

Drilling Sequence GS/Guided Kit

Guided Protocol using  Sleeves – Standard Platform & Narrow Line



		Drill 1	Drill 2	Drill 3	Drill 4	Drill 5	Sleeve
Narrow Line							
NL-SNAP-3-10	SBLA - Narrow	NL-GSSDL-2.35-6	NL-GSD-3.0-10				TUBE4-35-5L
NL-SNAP-3-11.5	SBLA - Narrow	NL-GSSDL-2.35-6	NL-GSD-3.0-10	NL-GSD-3.0-11.5			TUBE4-35-5L
NL-SNAP-3-13	SBLA - Narrow	NL-GSSDL-2.35-6	NL-GSD-3.0-10	NL-GSD-3.0-13			TUBE4-35-5L
NL-SNAP-3-16	SBLA - Narrow	NL-GSSDL-2.35-6	NL-GSD-3.0-10	NL-GSD-3.0-13	NL-GSD-3.0-16		TUBE4-35-5L
NL-SNAP-3.3-10	SBLA - Narrow	NL-GSSDL-2.35-6	NL-GSD-3.0-10	NL-GSD-3.3-10			TUBE4-35-5L
NL-SNAP-3.3-11.5	SBLA - Narrow	NL-GSSDL-2.35-6	NL-GSD-3.0-10	NL-GSD-3.3-11.5			TUBE4-35-5L
NL-SNAP-3.3-13	SBLA - Narrow	NL-GSSDL-2.35-6	NL-GSD-3.0-10	NL-GSD-3.3-13			TUBE4-35-5L
NL-SNAP-3.3-16	SBLA - Narrow	NL-GSSDL-2.35-6	NL-GSD-3.0-10	NL-GSD-3.3-13	NL-GSD-3.0-16		TUBE4-35-5L
Standard Line							
SNAP-3.75-8	SBLA - Standard	GSSDL-2.35-6	GSD-3.75-8				TUBE516
SNAP-3.75-10	SBLA - Standard	GSSDL-2.35-6	GSSDL-2.75-9	GSD-3.75-10			TUBE516
SNAP-3.75-11.5	SBLA - Standard	GSSDL-2.35-6	GSSDL-2.75-9	GSD-3.75-11.5			TUBE516
SNAP-3.75-13	SBLA - Standard	GSSDL-2.35-6	GSSDL-2.75-9	GSD-3.75-11.5	GSD-3.75-13		TUBE516
SNAP-3.75-16	SBLA - Standard	GSSDL-2.35-6	GSSDL-2.75-9	GSD-3.75-11.5	GSD-3.75-13	GSD-3.75-16	TUBE516
SNAP-4.2-8	SBLA - Standard	GSSDL-2.35-6	GSD-3.75-8	GSD-4.2-8			TUBE516
SNAP-4.2-10	SBLA - Standard	GSSDL-2.35-6	GSSDL-2.75-9	GSD-3.75-10	GSD-4.2-10		TUBE516
SNAP-4.2-11.5	SBLA - Standard	GSSDL-2.35-6	GSSDL-2.75-9	GSD-3.75-11.5	GSD-4.2-11.5		TUBE516
SNAP-4.2-13	SBLA - Standard	GSSDL-2.35-6	GSSDL-2.75-9	GSD-3.75-11.5	GSD-4.2-13		TUBE516
SNAP-4.2-16	SBLA - Standard	GSSDL-2.35-6	GSSDL-2.75-9	GSD-3.75-11.5	GSD-4.2-13	GSD-4.2-16	TUBE516
SNAP-5-6	SBLA - Standard	GSSDL-2.35-6	GSD-3.75-6	GSD-4.2-6	GSD-5.0-6		TUBE516
SNAP-5-8	SBLA - Standard	GSSDL-2.35-6	GSD-3.75-8	GSD-4.2-8	GSD-5.0-8		TUBE516
SNAP-5-10	SBLA - Standard	GSSDL-2.35-6	GSSDL-2.75-9	GSD-3.75-10	GSD-4.2-10	GSD-5.0-10	TUBE516
SNAP-5-11.5	SBLA - Standard	GSSDL-2.35-6	GSSDL-2.75-9	GSD-3.75-11.5	GSD-4.2-11.5	GSD-5.0-11.5	TUBE516
SNAP-5-13	SBLA - Standard	GSSDL-2.35-6	GSSDL-2.75-9	GSD-3.75-11.5	GSD-4.2-13	GSD-5.0-13	TUBE516
SNAP-5-16	SBLA - Standard	GSSDL-2.35-6	GSSDL-2.75-9	GSD-3.75-11.5	GSD-4.2-13	GSD-5.0-16	TUBE516

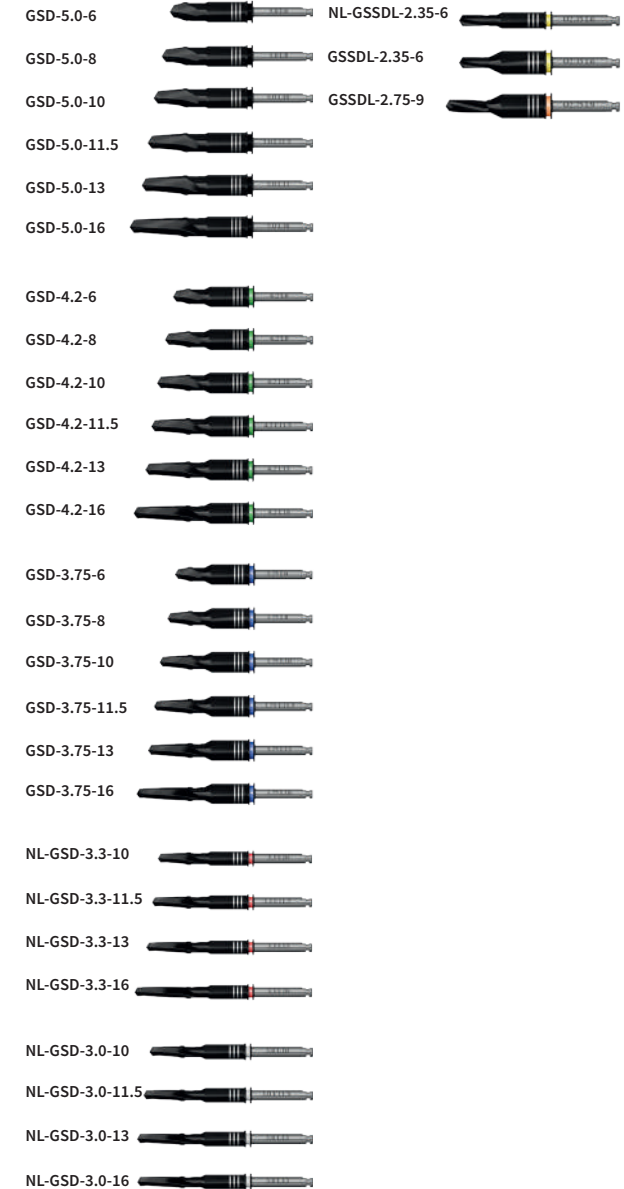

Libraries

The Ritter Implants system is currently represented in the following libraries from these manufacturers:

- 3Shape®
- Acteon®
- 3Diemme®
- Exocad®
- BlueSkyBio®
- Dental Wings®
- Dentique3D®
- Dentsply®
- Ewoosoft®
- KODAK®
- Ondemand®
- Planmeca®
- ProDigiDent®
- Sicat®
- Vatech®



Download Libraries for Exocad, Model Creator and 3shape
www.ritterimplants.com/implant-libraries

How to order your implants?



1. PICK YOUR IMPLANT SIZES

				5.0	6.0	
		3.75	4.2			6
3.0	3.3					8
						10
						11.5
						13
						16

LENGTH (mm)

WRITE AMOUNT IN EACH CELL



Visit our online shop!
www.ritterimplants.com

2. CHOOSE SURGICAL KIT

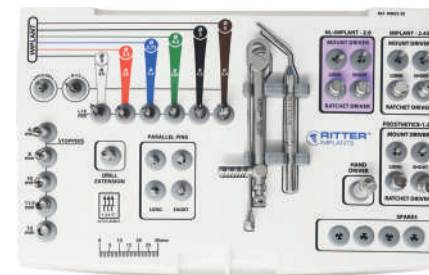

Compact Surgical Kit

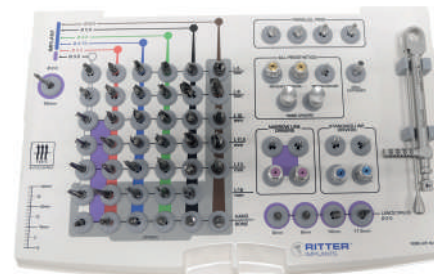

Complete Surgical Kit

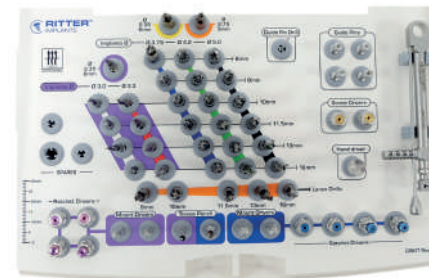

Guided Surgical Kit

Ritter Dental Units

Ritter has a wide range of Dental Units.



Vanguard Smart Dental Chair

IN STOCK NOW FOR IMMEDIATE DELIVERY!



High End German Quality
Dental Chair only

Vanguard Smart Dental Unit



High End German Quality
Complete Dental Unit

IN STOCK NOW FOR IMMEDIATE DELIVERY!



Vanguard **Dental Unit** without Cuspidor



Vanguard **Dental Unit** with Cuspidor

IN STOCK NOW FOR IMMEDIATE DELIVERY!

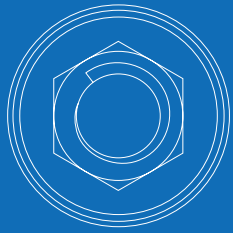

Manufacturer: Ritter Implants GmbH & Co. KG

**Freiburger Str. 45
88400 Biberach
Germany
+49 07351/52 925-10**

Pictures may differ from the original.
Errors and changes excepted.
The terms and conditions apply.
© Ritter Implants 2025

**www.ritterimplants.com
orders@ritterimplants.com**



**NOTICE:
NOT ALL ITEMS OF THIS CATALOG ARE APPROVED FOR SALES IN ALL COUNTRIES.
PLEASE CHECK THE IMPORT REGULATIONS OF YOUR TERRITORY.**

Worldwide Sales: Ritter Dental USA

**4310 West Avenue
San Antonio, Texas 78213
USA
1.855.807.8111**

